





## Sample Preparation



A Guide to Methods and Applications

**BIO-RAD**

		Trademarks .....	vi
		Introduction .....	vii
One	<b>Preliminary Techniques</b>		
			
		Particulate Removal .....	1
		Buffer and Reagent Ultrapurification .....	3
		Ionic Contaminants .....	4
		UV Absorbing and Polar Compounds .....	4
		Endotoxins .....	4
		References .....	5
		<b>Protein Concentration and Enrichment .....</b>	<b>6</b>
		Dilute Proteins .....	7
		Acidic and Basic Proteins .....	7
		Serum Proteins .....	9
		Albumin .....	9
		Antibodies .....	9
		References .....	13
Two	<b>Desalting and Buffer Exchange</b>		
			
		<b>Introduction .....</b>	<b>17</b>
		<b>Methods .....</b>	<b>18</b>
		MW > 2,000 Daltons (Gel Filtration) .....	18
		MW < 2,000 Daltons (Ion Exchange and Adsorption) .....	18
		References .....	20
Three	<b>Plasmid Purification and Probe Clean-up</b>		
			
		<b>Introduction .....</b>	<b>21</b>
		<b>Applications .....</b>	<b>22</b>
		Ethidium Bromide and Propidium Iodide Removal .....	22
		DNA Isolation from Agarose Gel .....	22
		Radioactive Label Removal .....	22
		Plasmid Purification .....	23
		Removal of PCR Inhibiting Contaminants .....	25
		References .....	25

Four — Detergent Removal



**Introduction** ..... 27

**Methods** ..... 28

Non-Ionic Detergents ..... 28

Ionic Detergents ..... 28

Sensitive or Dilute Protein Samples ..... 28

**References** ..... 29

Five — Ionic Contaminant Removal



**Introduction** ..... 31

**Deionization** ..... 31

Mechanism ..... 32

Methods ..... 32

Applications ..... 33

    Reagents, Buffers, and Water ..... 33

    Protein Samples ..... 33

    Carbohydrate Samples ..... 33

References ..... 33

**Metal Ion Removal** ..... 34

Mechanism ..... 35

    Metal Cations ..... 35

    Metal Anion Complexes ..... 35

    Metal Cation and Anion Removal ..... 35

Applications ..... 35

    Trace Metal Removal, Concentration, and Metal Analysis ..... 35

    Buffer Purification ..... 36

References ..... 36

**Anion and Cation Removal** ..... 38

Resin Selection Parameters ..... 39

    pH ..... 40

    Ionic Form ..... 40

    Porosity ..... 40

    Particle Size ..... 40

    Time and Temperature ..... 40

*(continued on next page)*

Applications.....	41
Ampholyte Removal.....	41
Organic Acids.....	42
Peptides and Amino Acids.....	42
Sugars and Sugar Alcohols.....	42
References.....	42

## Six Organic Compound Removal and Concentration



<b>Introduction.....</b>	<b>49</b>
<b>Mechanisms.....</b>	<b>50</b>
Hydrophobic Interaction.....	50
Gel Permeation.....	50
Ion Exchange.....	50
<b>Applications.....</b>	<b>50</b>
Biological Applications.....	50
Environmental Applications.....	51
Pesticides, PCB, and PAH.....	51
References.....	<b>51</b>

## Seven Columns and Accessories



<b>Introduction.....</b>	<b>55</b>
<b>Columns.....</b>	<b>55</b>
Small Volume.....	55
Bio-Spin Columns.....	55
Poly-Prep Columns.....	56
Intermediate Volume.....	56
Econo-Pac Columns.....	56
Large Volume.....	57
Econo-Column Columns.....	57
<b>Systems and Accessories.....</b>	<b>57</b>
Econo System.....	57
Flow Adaptors.....	58
Tubing and Fittings.....	58
Poly Column Rack.....	58

<b>Membrane Filters for Particulate Removal</b> .....	<b>59</b>
Prep-Disc Membrane Filters .....	59
Micro Prep-Disc Membrane Filters .....	59
<b>Ion Exchange Chromatography Resins</b> .....	<b>59</b>
Analytical Grade Resins .....	59
Prefilled Poly-Prep Columns .....	60
Biotechnology Grade Resins.....	61
Molecular Biology Grade Resins .....	61
Macro-Prep Ion Exchange Supports .....	61
Econo-Pac Cartridges.....	62
Bio-Gel A Ion Exchangers.....	62
<b>Hydrophobic Interaction Chromatography Supports</b> .....	<b>62</b>
Macro-Prep Supports.....	62
Econo-Pac Cartridges.....	63
Bio-Beads SM Adsorbents .....	63
<b>Gel Filtration Chromatography Supports</b> .....	<b>63</b>
Bio-Gel P Polyacrylamide Gels.....	63
Econo-Pac Columns and Cartridges .....	64
Bio-Gel A Agarose Gels .....	64
Bio-Beads S-X Beads .....	64
<b>Affinity Chromatography Supports</b> .....	<b>64</b>
Ready-to-Use Affinity Supports.....	64
Activated Affinity Supports.....	65
Carbodiimide Activated Supports.....	65
Econo-Pac Columns and Cartridges .....	66
<b>Hydroxyapatite Chromatography Supports</b> ....	<b>66</b>
Bio-Gel Hydroxyapatite Media .....	66
Macro-Prep Hydroxyapatite Supports .....	66
Econo-Pac Cartridges.....	66
<b>DNA Purification Supports</b> .....	<b>67</b>
Prep-A-Gene DNA Purification Reagents .....	67
InstaGene DNA Purification Matrix .....	67
<b>Chromatography Columns</b> .....	<b>67</b>
Standard Econo-Column Columns .....	67
Standard Jacketed Econo-Column Columns .....	69

*(continued on next page)*

Open-Ended Jacketed Econo-Column Columns...	69
Flow Adaptors .....	69
Glass Reservoirs .....	69
Econo-Column Funnels.....	69
Bio-Spin Columns .....	69
Poly-Prep Columns .....	69
Econo-Pac Columns.....	70
<b>Econo Systems and Accessories .....</b>	<b>70</b>
Econo Systems.....	70
Tubing .....	70
Poly Column Rack.....	70

Nine Literature Available

Literature Available.....	<b>71</b>
---------------------------	-----------

## Trademarks

The following trademarks and registered trademarks used in this guide are the property of Bio-Rad Laboratories.

Affi-Gel®	Bio-Sil®	Macro-Prep®
Affi-Prep®	Bio-Spin®	MAPS®
AG®	Chelex®	Poly-Prep®
Bio-Beads®	Econo-Column®	Prep-A-Gene®
Bio-Gel®	Econo-Pac®	Prep-Disc®
Bio-Rad®	GS Gene Prep®	
Bio-Rex®	InstaGene™	

The following trademarks are the property of the companies listed.

PCR is covered by U. S. patent number 4,683,202, issued to Cetus Corporation

Cibacron is a trademark of Ciba-Geigy

Dowex is a trademark of Dow Chemical Company

Norprene, Fluran, PharMed and Tygon are trademarks of Norton Co

Amberlite, Plexiglas, Triton, Tween, and XAD are trademarks of Rohm and Haas Company

# Introduction

Sample preparation involves a wide range of techniques which, in most cases, make use of small chromatographic columns, filters, and media to transform a sample which cannot be directly analyzed into one that fits the requirements of the analytical technique to be used. In the past, sample preparation techniques have been most closely associated with classical chromatographic analysis. Currently there is a growing interest in sample preparation for other analytical methods in molecular biology and biotechnology. This guide will assist the biochemist or molecular biologist in selecting appropriate sample preparation methods. It covers common techniques in sample preparation and explains separation strategies and alternatives.

Bio-Rad offers a complete line of products for sample preparation applications, and a technical staff to assist you in designing an effective protocol for your application. For more information on products or applications, contact your Bio-Rad representative, or, in the US, call 1-800-4BIORAD and press 2 for technical service.





# Preliminary Techniques

## Particulate Removal

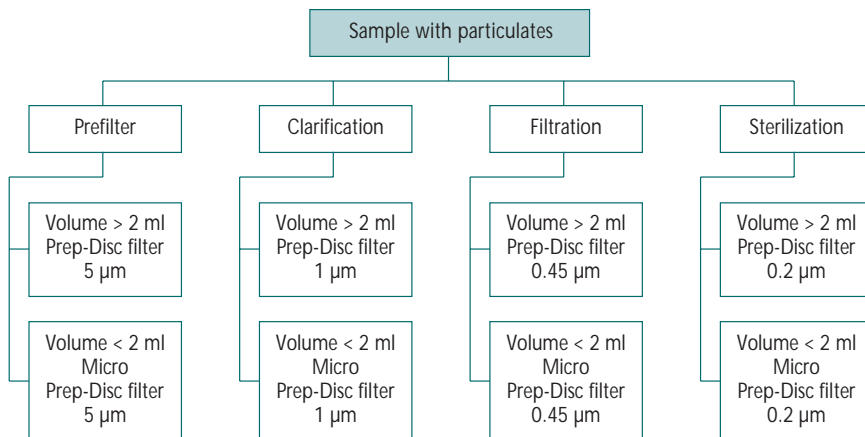

Table 1.1. Guide to Particulate Removal

Filtration for particulate removal is the simplest and most common sample preparation procedure. It is commonly used before sample injection to minimize particulate clogging of lines and valves, to protect valuable HPLC columns, and to maintain the integrity of liquid chromatography columns. Filtration is also used for the clarification of liquids, sterilization of tissue culture media and other liquids, and ultracleaning of water and alcohols.

Prefiltration, clarification, filtration, and sterilization techniques are defined by the size of the particles removed from solution (Table 1.1). Prefiltration is the removal of large particulates ( $>5 \mu\text{m}$ ), clarification is the removal of visible particulates ( $>1 \mu\text{m}$ ), filtration is the removal of most particulates ( $>0.45 \mu\text{m}$ ), and sterilization is filtration that also removes bacterial contaminants ( $>0.2 \mu\text{m}$ ). The  $0.45 \mu\text{m}$  pore size is the most commonly used filter and is employed in most HPLC applications. Prefiltration is also highly recommended to remove large particles that may clog smaller pore size filters.

Bio-Rad offers two filter types, the Prep-Disc and Micro Prep-Disc filters. Each type is available in four pore sizes (5, 1, 0.45, and  $0.2 \mu\text{m}$ ). The filters are syringe mountable and provide quick and easy particulate removal. They may be autoclaved for



sterile use, and offer a high surface area for fast flow rates. The filters are non-contaminating, and contain no extractables detected with UV absorbance at 190–370 nm.



*Membrane filters.*

**Table 1.2. Membrane Filter Specifications**

	Prep-Disc Filter	Micro Prep-Disc Filter
Construction	Polypropylene housing; PTFE membrane	Polypropylene housing; PTFE membrane
Dimensions	2.5 cm long x 2.5 cm diameter	2.0 cm long x 0.3 cm diameter
Connections		
Inlet	Female luer lock with locking tabs	Female luer lock with locking tabs
Outlet	Male luer taper	Male luer taper
Retention volume (with air purge)	< 0.5 ml	< 10 $\mu$ l
Process volume	2–100 ml	< 2 ml
Solvent and sample compatibility	Organic solutions, acids, and bases	Organic solutions, acids, and bases
Filter area	4.3 cm <sup>2</sup>	0.07 cm <sup>2</sup>



## Buffer and Reagent Ultrapurification

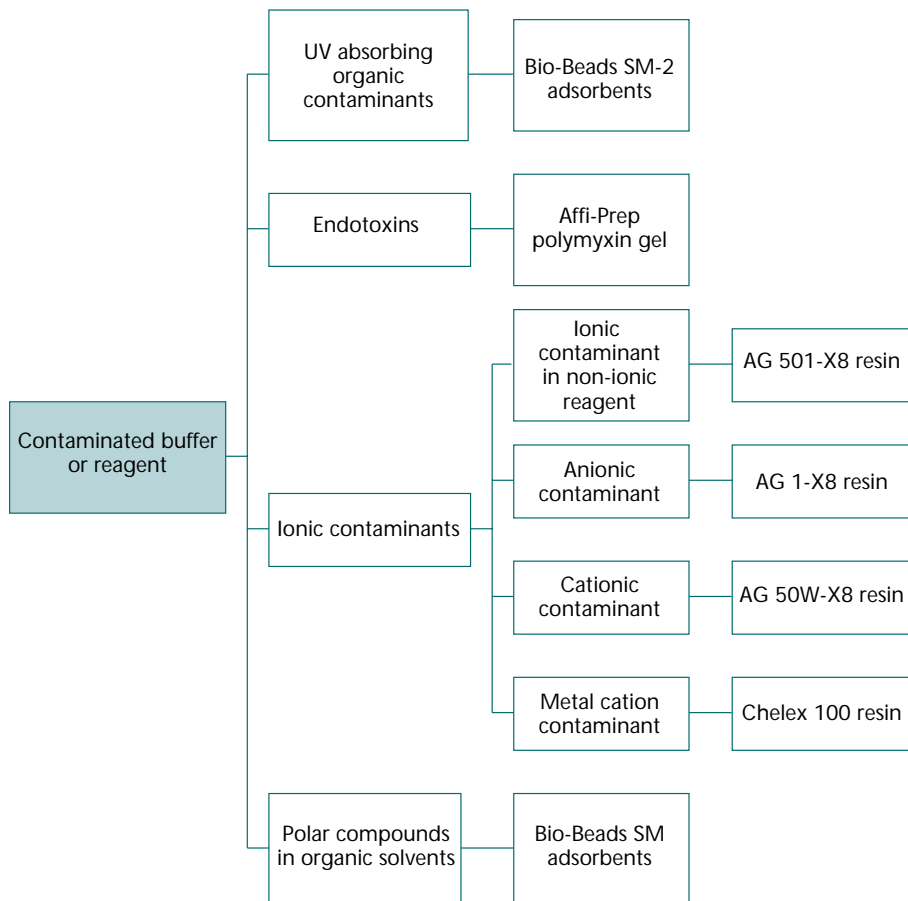

Table 1.3. Guide to Buffer and Reagent Ultrapurification

In the purification and separation of proteins, extremely pure buffers must be used to obtain optimal results. High buffer purity is required for electrophoresis, HPLC, and sensitive enzyme studies. For example, in electrophoresis applications, urea and formamide frequently must be deionized prior to use. Deionization removes impurities that can cause band broadening, high background noise, and gel artifacts. Similarly, buffers contaminated with heavy metal ions and UV absorbing impurities can cause high background noise and unstable baselines with the sensitive detectors used in HPLC analysis.



## Ionic Contaminants

Ionic contaminants in buffers and reagents are easily removed using ion exchange chromatography. Strong anion and cation exchange resins, such as AG 1-X8 resin and AG 50W-X8 resin, are used for reagent clean-up, while Chelex 100 chelating resin is used to purify aqueous solutions and buffers.

AG 501-X8 mixed bed resin contains equivalent amounts of AG 1-X8 and AG 50W-X8 resins, making this exchanger ideal for general purpose deionization of non-ionic reagents such as urea, glyoxal, formamide, and acrylamide. Deionization is fast and easy; contaminated reagents can be completely deionized within an hour using simple batch techniques.

Buffer purification is easily accomplished using Chelex 100 chelating resin. Chelex 100 resin is highly selective for polyvalent cations, making it uniquely suited to specifically remove heavy metals from aqueous solutions and buffers without altering the concentration of monovalent ions. Chelex resin has been used to purify many buffers, including HEPES-KCl, Tris-HCl, PIPES, and phosphate buffers.

## UV Absorbing and Polar Compounds

Neutral macroporous polymeric beads, like Bio-Beads SM-2 adsorbents, are useful for removing UV absorbing impurities from buffers and unbound fluorescent dyes from labeled antibodies. Bio-Beads SM-2 and SM-4 non-polar polystyrene adsorbents are particularly useful for the removal of non-polar substances or surface-active agents from aqueous solutions. Bio-Beads SM-7 adsorbents are slightly more polar than the other types of Bio-Beads adsorbents and can adsorb polar compounds from non-polar solvents or non-polar compounds from polar solvents.

## Endotoxins

Endotoxins, pyrogenic lipopolysaccharides of gram negative-bacteria, are widespread contaminants of aqueous and physiological solutions. The removal of endotoxins from solutions intended for biological applications is especially crucial for *in vivo* applications. The Affi-Prep polymyxin support binds endotoxin molecules with high capacity and selectivity. The support is pressure rated to 1,000 psi and can be sanitized and regenerated, making it ideal for both research and process applications.



## References

Application	Product	Reference
<b>Buffer clean-up</b>	Chelex resin	Jefferson, J. R., <i>et al.</i> , <i>Biochem.</i> , <b>29</b> , 6687 (1990); Kalyanaraman, B., <i>et al.</i> , <i>Biochem.</i> , <b>28</b> , 4839 (1989); Kupke, D. W. and Fox, J. W., <i>Biochem.</i> , <b>28</b> , 4409 (1989); Pai, S-C., <i>et al.</i> , <i>Anal. Chem.</i> , <b>62</b> , 774 (1990); Shang, Z., <i>et al.</i> , <i>Biochem.</i> , <b>28</b> , 9790 (1989); Shrake, A., <i>et al.</i> , <i>Biochem.</i> , <b>28</b> , 6281 (1989).
HEPES, KCl	Chelex resin	Crouch, T. H. and Klee, C. B., <i>Biochem.</i> , <b>19</b> , 3692 (1980).
MOPS	Chelex resin	Tsai, T.-C., <i>et al.</i> , <i>Biochem.</i> , <b>24</b> , 3180 (1985).
PIPES-KCl	Chelex resin	Swanson, J. E. and Feigenson, G. W., <i>Biochem.</i> , <b>29</b> , 8291 (1990).
Potassium phosphate	Chelex resin	Ortiz de Montellano, P. R. and Grab, L. A., <i>Biochem.</i> , <b>26</b> , 5310 (1987).
Sodium phosphate	Chelex resin	Kaplan, B. B., <i>et al.</i> , <i>Biochem.</i> , <b>17</b> , 5516 (1978); Reiss, P. D., <i>et al.</i> , <i>Anal. Biochem.</i> , <b>140</b> , 162 (1984).
TBS	Chelex resin	Busby, T. F. and Ingham, K. C., <i>Biochem.</i> , <b>26</b> , 5564 (1987).
TES, NaCl	Chelex resin	Burger, D., <i>et al.</i> , <i>Biochem.</i> , <b>23</b> , 1966 (1984).
bis-Tris	Chelex resin	Gupta, R. K., <i>J. Biol. Chem.</i> , <b>251</b> , 6815 (1976).
Tris-HCl	Chelex resin	Ma, C. and Ray, W. J., <i>Biochem.</i> , <b>19</b> , 751 (1980); Yeh, Y., <i>et al.</i> , <i>Biochem.</i> , <b>18</b> , 882 (1979).
Tris-HCl, DTT	Chelex resin	Miziorko, H. M. and Sealy, R. C., <i>Biochem.</i> , <b>19</b> , 1167 (1980).
Tris-HCl, HEPES-KOH, KCl	Chelex resin	Hunt, J. B. and Ginsburg, A., <i>Biochem.</i> , <b>20</b> , 2226 (1981).
Veronal-buffered saline	Chelex resin	Bartholomew, R. M. and Esser, A. F., <i>Biochem.</i> , <b>19</b> , 2847 (1980).
Water, KOH	Chelex resin	Smithers, G. W. and O'Sullivan, W. J., <i>J. Biol. Chem.</i> , <b>257</b> , 6164 (1982).
<b>Deionization</b>		
Acrylamide	AG 501-X8 resin	Seneary, D. F. and Ackers, G. K., <i>Biochem.</i> , <b>29</b> , 6568 (1990).
Formamide	AG 501-X8 resin	Dozin, B., <i>et al.</i> , <i>Biochem.</i> , <b>24</b> , 5581 (1985); Jaeger, J. A., <i>et al.</i> , <i>Biochem.</i> , <b>29</b> , 10147 (1990)
Lubrol-PX	AG 501-X8(D) resin	Moore, A. C., <i>et al.</i> , <i>Biochem.</i> , <b>21</b> , 6212 (1982).
Urea	AG 501-X8 resin	Hutchens, T. W. and Yip, T.-T., <i>J. Chromatog.</i> , <b>500</b> , 531 (1990); Ropson, I. J., <i>et al.</i> , <i>Biochem.</i> , <b>29</b> , 9591 (1990); Seneary, D. F. and Ackers, G. K., <i>Biochem.</i> , <b>29</b> , 6568 (1990).
<b>Endotoxin removal</b>	Affi-Prep polyclonal support	Talmadge, K. W. and Siebert, C. J., <i>J. Chromatog.</i> , <b>476</b> , 175 (1989).



# Protein Concentration and Enrichment

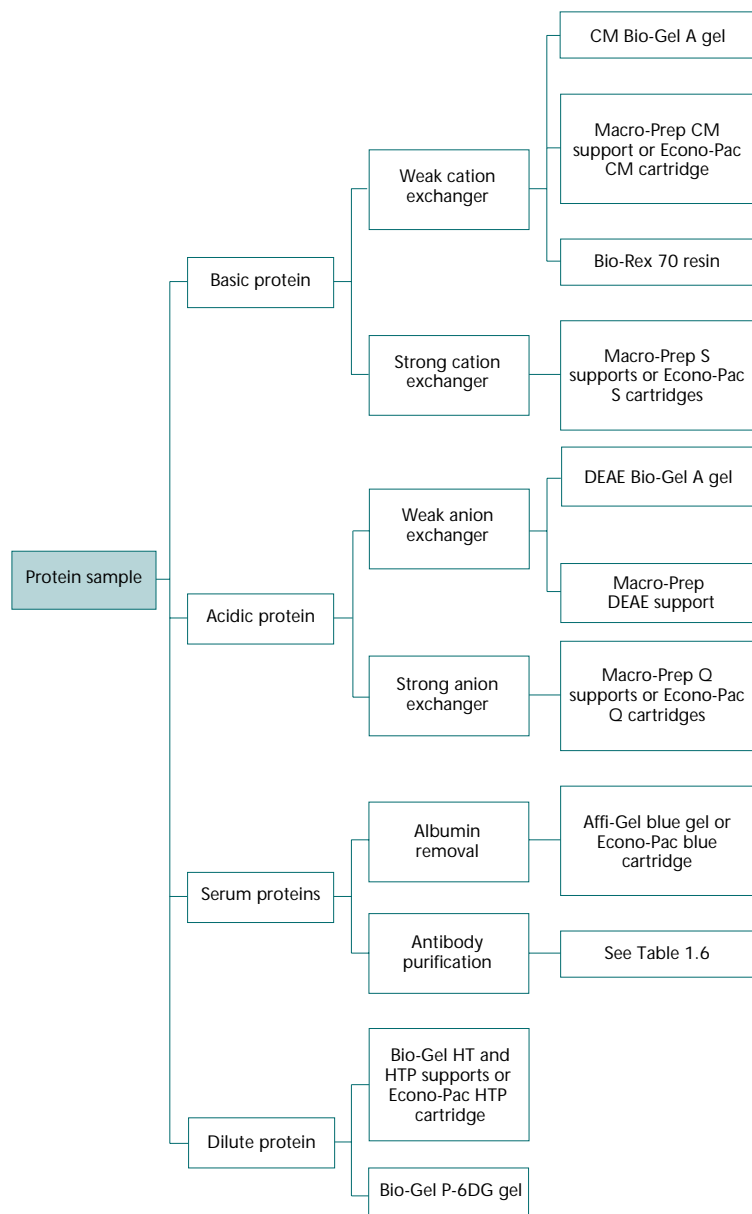

Table 1.4. Guide to Protein Concentration and Enrichment



Protein concentration is often necessary following analysis or purification so that further procedures can be performed. In addition, proteins are generally more stable in relatively concentrated solutions. The optimal method of protein concentration depends on the volume of the sample, the type of protein, the type of buffer employed, and whether or not the application requires separating the protein from other components.

## Dilute Proteins

A rapid and inexpensive method for protein concentration, which eliminates the problems associated with lyophilization and chemical precipitation, is accomplished with Bio-Gel hydroxyapatite media. Hydroxyapatite, a form of calcium phosphate, has a high capacity for proteins and other macromolecules, yet does not bind low molecular weight substances. Selective elution with either step or linear phosphate gradients separates proteins from small molecules and can also concentrate or fractionate proteins. A batch technique, however, provides the most efficient method for concentrating very dilute protein solutions. Hydroxyapatite media is available either hydrated or as a dry powder. It is also available in convenient prepacked Econo-Pac HTP cartridges suitable for small sample preparation applications.

Dilute protein samples can also be concentrated using Bio-Gel P-6DG desalting gel. The solution to be concentrated is placed in dialysis tubing which is then covered with dry gel. The sample is concentrated as water diffuses out of the tubing into the gel. Bio-Gel P-6DG gel provides a simple concentration method for samples of 5 ml or greater.

## Acidic and Basic Proteins

Ion exchange chromatography can be used to concentrate and purify many proteins. Since proteins are amphoteric molecules, the net charge of a given protein can be manipulated by altering its pH. At a  $\text{pH} > \text{pI}$ , proteins are negatively charged, while at  $\text{pH} < \text{pI}$ , proteins are positively charged (Table 1.5). Thus, cation or anion exchange resins can be used to bind any given protein. However, since most proteins maintain activity at a physiological pH, it is usually desirable to keep protein solutions at or near neutral pH. It is also important to consider the  $\text{pI}$  of the molecule of interest in relation to the  $\text{pI}$ s of the contaminants to be removed, as it may be necessary to select a pH range outside of the physiological range to obtain the desired separation.





**Table 1.5 Properties of Acidic and Basic Proteins at Physiological pH**

Protein Type	Binding pH Range	At pH 7	Resin Type
Acidic protein $pI < 7$	$pH = 1 \text{ unit} > pI$	Negative net charge	Anion exchange resin
Basic protein $pI > 7$	$pH = 1 \text{ unit} < pI$	Positive net charge	Cation exchange resin

Bio-Rad offers strong and weak cation and anion supports for protein concentration and purification. Strong ion exchangers like the Macro-Prep Q and S supports can be used over a wide pH range (1-10), while weak ion exchangers operate over narrower pH ranges (see table 1.6). The Macro-Prep supports are available in Econo-Pac cartridges, which are ideal for small sample preparation applications. In addition, due to their exceptional mechanical and chemical stability, these supports are ideal for scale-up applications.

**Table 1.6 Ion Exchange Supports for Protein Concentration and Purification**

	Support Type	Functional Ligand	Operating pH Range	Capacity
Macro-Prep Q support	strong anion	$N^+(CH_3)_3$	1-10	>15 mg BSA/ml
Macro-Prep high Q support	strong anion	$N^+(CH_3)_3$	1-10	>25 mg BSA/ml
Macro-Prep S support	strong cation	$SO_3^-$	1-10	>35 mg IgG*/ml
Macro-Prep high S support	strong cation	$SO_3^-$	1-10	>55 mg IgG*/ml
Macro-Prep DEAE support	weak anion	$N^+(C_2H_5)_2$	4-8	>30 mg BSA/ml
DEAE Bio-Gel A gel	weak anion	$N^+(C_2H_5)_2$	2-9.5	45±10 mg/ml hemoglobin
Macro-Prep CM support	weak cation	$COO^-$	4-13	>20 mg BSA/ml
CM Bio-Gel A gel	weak cation	$COO^-$	4.5-10	45±10 mg/ml hemoglobin
Bio-Rex 70 resin	weak cation	$COO^-$	5-14	0.5 meq/ml

\*Human IgG



## Serum Proteins

### *Albumin*

Albumin, the major serum constituent, can be effectively removed from plasma and serum by affinity chromatography with Affi-Gel blue gel. This gel can quickly remove more than 95% of the serum albumin with little non-specific adsorption of the other serum proteins. The binding of albumin is so strong that a high concentration of salt or chaotropic reagent is required to desorb it. Other serum proteins either do not bind to Affi-Gel blue gel or can be eluted with relatively low concentrations of salt. Affi-Gel blue gel is available in two mesh sizes; a faster flowing 50-100 mesh, and a higher capacity, slower flowing 100-200 mesh. It is also available in convenient Econo-Pac blue cartridges for easy sample preparation.

### *Antibodies*

Bio-Rad offers chromatography supports, columns cartridges, and kits for sample preparation in antibody purification applications. Ion exchange, affinity, gel filtration, hydrophobic interaction (HIC), and hydroxyapatite techniques are all used for antibody samples. The choice of technique depends upon many factors, including sample complexity, sample volume, and the purification goal. Combinations of these techniques can be used to increase the final level of purity (Table 1.7).

Dye-ligand affinity chromatography, using DEAE and CM Affi-Gel blue products, is useful for the purification of monoclonal and polyclonal antibodies from serum. CM and DEAE Affi-Gel blue gels are bifunctional gels that combine ion exchange and dye affinity chromatography to bind albumin and other serum proteins. These gels will remove albumin and protease from serum or ascites fluid for the preparation of protease-free antibodies or enriched serum samples. DEAE Affi-Gel blue gel is available in convenient Econo-Pac cartridges, Econo-Pac serum IgG purification columns and in a kit format which includes everything necessary to purify IgG from serum.

Hydroxyapatite, a crystalline form of calcium phosphate, provides excellent resolution using gentle separation conditions. Hydroxyapatite can be used for the purification of polyclonal and monoclonal antibodies, the separation of IgG from IgM, light chain analysis, and the concentration of antibody from large volumes of cell culture supernatant. Econo-Pac HTP cartridges provide the most convenient format for using hydroxyapatite with low pressure chromatography set-ups. Hydroxyapatite chemistry is also available in a Macro-Prep support. The Macro-Prep Ceramic Hydroxyapatite support is ideal for scale-up applications due to its high chemical and mechanical stability.



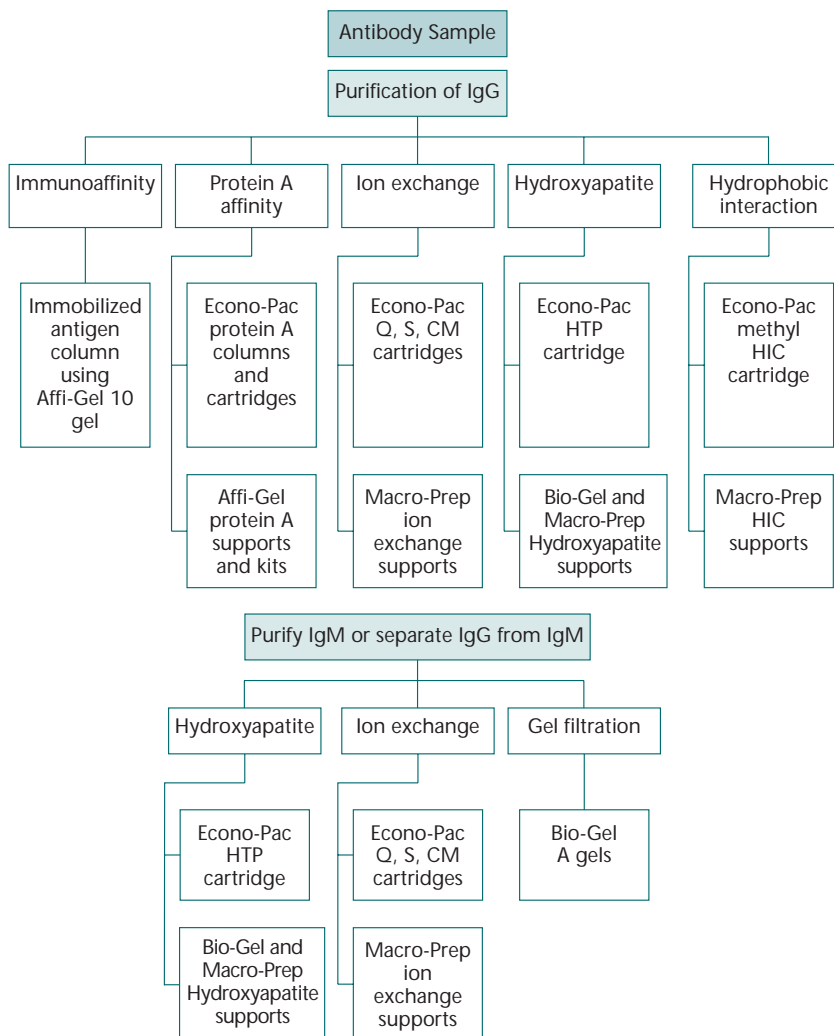

Table 1.7. Guide to Antibody Purification

Protein A, a bacterial-coat protein from *Staphylococcus aureus*, binds the Fc portion of immunoglobulins. This specificity insures a high level of purity. Protein A affinity chromatography is especially useful for the purification of monoclonal mouse IgG, including mouse IgG<sub>1</sub>, as well as human and rabbit IgG. Protein A affinity supports, kits, prepacked columns, and cartridges are available to make these applications convenient.



Gel filtration with Bio-Gel A-0.5 ml gel may be used for the separation of IgG from IgM by exploiting the molecular weight and size differences between them. Additionally, desalting columns (packed with gel filtration supports) such as Econo-Pac 10DG columns or Econo-Pac P6 cartridges are useful in many protocols. Desalting or buffer exchange is often required between purification steps and the use of desalting columns rather than dialysis can save time.

Hydrophobic interaction chromatography (HIC) can be used as a faster and higher resolution alternative to ammonium sulfate precipitation steps. HIC has been shown to be the technique of choice for the purification of certain rat antibodies and as a second step after ion exchange for the purification of mouse antibodies. Bio-Rad offers a mildly hydrophobic Macro-Prep methyl HIC support and a more hydrophobic Macro-Prep t-butyl support. The Macro-Prep HIC supports are available in 1 ml and 5 ml Econo-Pac cartridges for easy sample preparation.



*Econo-Pac cartridges.*



**Table 1.8. Econo-Pac Cartridge Specifications**

Application	Cartridge Name	Functional Group	Bed Volume	Protein Capacity	Recommended Flow Rate
Protein and plasmid purification	Econo-Pac high Q cartridge	-N <sup>+</sup> (CH <sub>3</sub> ) <sub>3</sub>	5 ml	≥170 mg BSA	1.0–3.0 ml/min
			1 ml	40 mg BSA	0.5–1.0 ml/min
Protein and plasmid purification	Econo-Pac Q cartridge	-N <sup>+</sup> (CH <sub>3</sub> ) <sub>3</sub>	5 ml	75 mg ferritin	1.0–3.0 ml/min
			1 ml	15 mg ferritin	0.5–1.0 ml/min
Protein purification	Econo-Pac high S cartridge	-SO <sub>3</sub> <sup>-</sup>	5 ml	≥230 mg human IgG	1.0–3.0 ml/min
			1 ml	55 mg human IgG	0.5–1.0 ml/min
Protein purification	Econo-Pac S cartridge	-SO <sub>3</sub> <sup>-</sup>	5 ml	175 mg human IgG	1.0–3.0 ml/min
			1 ml	35 mg human IgG	0.5–1.0 ml/min
Protein purification cartridge	Econo-Pac CM	-COO <sup>-</sup>	5 ml	125 mg hemoglobin	1.0–3.0 ml/min
			1 ml	25 mg hemoglobin	0.5–1.0 ml/min
Protein purification	Econo-Pac t-Butyl HIC cartridge	-OC(CH <sub>3</sub> ) <sub>3</sub>	5 ml	≥65 mg HSA	0.5–3.0 ml/min
			1 ml	≥15 mg BSA	0.5–1.0 ml/min
Protein purification	Econo-Pac methyl HIC cartridge	-OCH <sub>3</sub>	5 ml	40 mg BSA	0.5–3.0 ml/min
			1 ml	8 mg BSA	0.5–1.0 ml/min
Protein and nucleic acid purification	Econo-Pac HTP cartridge	[Ca <sub>5</sub> (PO <sub>4</sub> ) <sub>3</sub> OH] <sub>2</sub>	5 ml	15 mg BSA	0.5 ml/min
			1 ml	30 mg lysozyme	0.6–0.8 ml/min
				3 mg BSA 6 mg lysozyme	
Antibody purification	Econo-Pac protein A cartridge	Protein A	5 ml	34 mg mouse monoclonal IgG 70 mg human IgG	0.5–1.5 ml/min
			1 ml	8 mg mouse monoclonal IgG 16 mg human IgG	0.1–0.5 ml/min
				—	
Desalting, buffer exchange	Econo-Pac P6 cartridge	—	5 ml	100 μl to 3.0 ml sample volumes	0.5–1.0 ml/min
Purification of growth factors, proteases, DNA-binding proteins, endonucleases	Econo-Pac heparin cartridge	Heparin	5 ml	Varies greatly depending on the protein	1.0–3.0 ml/min
IgG purification	Econo-Pac DEAE blue cartridge	Cibacron Blue F3GA and DEAE	5 ml	0.3–1.0 ml serum sample volumes	0.5–2.5 ml/min
Albumin removal, purification of serum proteins, various enzymes	Econo-Pac blue cartridge	Cibacron blue F3GA dye	5 ml	0.3–1.0 ml serum sample volumes	0.5–2.5 ml/min



## References

Application	Product	Reference
Albumin removal from serum	Affi-Gel blue gel	Razavi, M.H., <i>et al.</i> , <i>Am. J. Hypertens.</i> , <b>1</b> , 91S-95Sm (1988).
Anti-idiotypic antibody purification	Affi-Gel 10 gel	Lacy, M. J., <i>et al.</i> , <i>J. Immunol.</i> , <b>142</b> , 3482(1989). Lombes, M., <i>et al.</i> , <i>J. Immunol.</i> , <b>143</b> , 4078 (1989).
Anti-peptide antibody purification	Affi-Gel protein A gel	Okamoto, T., <i>et al.</i> , <i>Cell</i> , <b>62</b> , 709 (1990).
Antibody conjugate purification	Bio-Gel P-30 gel	Zaidi, M., <i>et al.</i> , <i>Clin. Chem.</i> , <b>34</b> , 655 (1988).
Antibody coupling	Affi-Gel 10 gel	Brattsand, G., <i>et al.</i> , <i>J. Immunol.</i> , <b>144</b> , 3651 (1990). Douglas, C.M. and Collier, R., <i>J. Biochem.</i> , <b>29</b> , 5043 (1990).
Antibody purification	Bio-Gel A-5m gel Affi-Gel 10 gel Affi-Gel 15 gel Protein A MAPS buffers	Liu, Z. Y., <i>et al.</i> , <i>J. Immunol.</i> , <b>142</b> , 2370 (1989). Bequinot, L., <i>et al.</i> , <i>Proc. Natl. Acad. Sci. USA</i> , <b>82</b> , 2774 (1985); Feeney, A. J. and Thueraur, D. J., <i>J. Immunol.</i> , <b>143</b> , 4061, (1989); Larrodera, P., <i>et al.</i> , <i>Cell</i> , <b>61</b> , 1113 (1990); Segev, N., <i>et al.</i> , <i>Proc. Natl. Acad. Sci. USA</i> , <b>82</b> , 1531 (1985). Makker, S. P., <i>et al.</i> , <i>J. Immunol.</i> , <b>142</b> , 2264 (1989). Tomkinson, B.E., <i>et al.</i> , <i>J. Immunol.</i> , <b>142</b> , 2230 (1989).
Antibody purification from crude antiserum	Affi-Gel 15 gel	Wildgoose, P., <i>et al.</i> , <i>Biochem.</i> , <b>29</b> , 3413 (1990).
Antigen purification	Affi-Gel 10 gel	Brooks, K. H. and Feldbush, T. L., <i>J. Immunol.</i> , <b>127</b> , 963 (1981); Suzuki, Y., <i>et al.</i> , <i>J. Clin. Microbiol.</i> , <b>28</b> , 1734 (1990).
Antigenic protein fractionation	Hydroxyapatite	Vosti, K. L., <i>J. Med. Microbiol.</i> , <b>11</b> , 453 (1978).
Antisera purification	Affi-Gel 10 gel Affi-Gel 15 gel	Glick, A.B., <i>et al.</i> , <i>Cell Regulation</i> , <b>1</b> , 87 (1989). Enos, A. P., and Morris, N. R. , <i>Cell</i> , <b>60</b> , 1019 (1990).
Ascites fluid absorption	Affi-Gel blue gel	Lacy, M. J., <i>et al.</i> , <i>J. Immunol.</i> , <b>142</b> , 3482 (1989).
DNA A protein separation from <i>E. coli</i>	Bio-Rex 70 resin	Sekimizu, K., <i>et al.</i> , <i>J. Biol. Chem.</i> , <b>263</b> , 7136 (1988).
Enzyme purification	Hydroxyapatite	Barry, III, C. E., <i>et al.</i> , <i>Biochem.</i> , <b>28</b> , 6323 (1989); Schott, K., <i>et al.</i> , <i>J. Biol. Chem.</i> , <b>265</b> , 4204 (1990); Ghosh, G., <i>et al.</i> , <i>Biochem.</i> , <b>29</b> , 2220 (1990); Shayiq, R. M. and Avadhani, N. G., <i>Biochem.</i> , <b>29</b> , 866 (1990).
Exonuclease purification	Bio-Rex 70 resin Hydroxyapatite	Perrino, F. W. and Loeb, L. A., <i>Biochem.</i> , <b>29</b> , 5226 (1990). Perrino, F. W. and Loeb, L. A., <i>Biochem.</i> , <b>29</b> , 5226 (1990).
Extraction of GIII A	Bio-Rex 70 resin	Cruz, L. J., <i>et al.</i> , <i>Biochem.</i> , <b>28</b> , 3437 (1989).
F(ab) <sub>2</sub> fragment purification	Affi-Gel protein A gel	Tsuchiya, N., <i>et al.</i> , <i>J. Immunol.</i> , <b>144</b> , 4742 (1990).



Application	Product	Reference
Factor D purification	Hydroxyapatite	Fry, M., <i>et al.</i> , <i>Biochem.</i> , <b>24</b> , 7549 (1985).
Fractionation of plasma proteins	Affi-Gel blue gel	Gianazza, E. and Arnaud, P., <i>J. Biochem.</i> , <b>201</b> , 129 (1982).
Glycoprotein purification	Hydroxyapatite	Gorbunoff, M. J., <i>J. Chromatog.</i> , <b>187</b> , 224 (1980).
Hemocyanin purification	Bio-Rex 70 resin	Moore, M. D., <i>et al.</i> , <i>J. Biol. Chem.</i> , <b>261</b> , 10511 (1986).
Hemoglobin separation from blood	Bio-Rex 70 resin	Ersser, R. S., <i>et al.</i> , <i>Biomedical Chromatog.</i> , <b>1</b> , 183 (1986).
Histone purification	Bio-Rex 70 resin	D'Anna, J. A., <i>et al.</i> , <i>Biochemistry</i> , <b>18</b> , 943 (1979); Walker, J., <i>et al.</i> , <i>J. Biol. Chem.</i> , <b>265</b> , 5736 (1990).
IgG purification	DEAE Affi-Gel blue gel	Hori, M. T. and Abrass, C. K., <i>J. Immunol.</i> , <b>144</b> , 3849 (1990).
	Affi-Gel protein A gel	Moellering, B. J., <i>et al.</i> , <i>BioPharm</i> , <b>30</b> (Feb. 1990).
	Bio-Gel A-1.5m gel	Graham, I. L., <i>et al.</i> , <i>J. Immunol.</i> , <b>142</b> , 2352 (1989).
	DEAE Affi-Gel blue gel	Andrews, R. K., <i>et al.</i> , <i>Biochem.</i> , <b>28</b> , 8326 (1989); Usui, S., <i>et al.</i> , <i>Biochem.</i> , <b>29</b> , 4618 (1990).
IgG quantitation	Affi-Prep protein A gel	Compton, B. J., <i>et al.</i> , <i>Anal. Chem.</i> , <b>61</b> , 1314 (1989).
IgG removal	Affi-Gel 10 gel	Alters, S. E., <i>et al.</i> , <i>J. Immunol.</i> , <b>1454</b> , 4587 (1990).
IgG <sub>1</sub> coupling	Affi-Gel 10 gel	Tawil, N. J., <i>et al.</i> , <i>Biochem.</i> , <b>29</b> , 6540 (1990).
IgG <sub>1</sub> purification	Affi-Gel blue gel	Shen, L., <i>et al.</i> , <i>J. Immunol.</i> , <b>143</b> , 4117 (1989); Tawil, N.J., <i>et al.</i> , <i>Biochem</i> , <b>29</b> , 6540 (1990).
IgG <sub>1</sub> , IgG <sub>2a</sub> and IgM purification	Affi-Gel protein A column and hydroxyapatite	Altieri, D. C. and Edgington, T. S., <i>J. Immunol.</i> , <b>145</b> , 246 (1990).
IgM and IgG purification from sheep and cattle serum	CM Affi-Gel blue gel	Schmerr, M. J. F., <i>et al.</i> , <i>J. Chromatog.</i> , <b>326</b> , 225 (1985).
IgM purification from serum	Bio-Gel P-200 gel	Pretzman, <i>et al.</i> , <i>J. Immunol. Methods</i> , <b>83</b> , 301 (1985).
Immune complex isolation	Affi-Gel protein A gel	Nagafuchi, A. and Takeichi, M., <i>Cell Regulation</i> , <b>1</b> , 37 (1989).
	Bio-Gel A-1.5m gel	Levinson, S. S., <i>et al.</i> , <i>Clin. Chem.</i> , <b>34</b> , 784 (1988).
Isolation of human albumin	CM Affi-Gel blue gel	Podulso J. F. and Curran, G. L., <i>Proc. Natl. Acad. Sci. USA</i> , <b>89</b> , 2218 (1992).
Lambda and Kappa light chain separation	DEAE Bio-Gel A gel	Dalal, F. R. and Winsten, S., <i>Clin. Chem.</i> , <b>25</b> , 1 (1979).
Lipoprotein fractionation	Hydroxyapatite	Kostner, G. and Holasek, A., <i>Biochim. Biophys. Acta</i> , <b>488</b> , 417 (1977).
Monoclonal antibody coupling	Affi-Gel 10 gel	Wilden, P.A., <i>et al.</i> , <i>Biochem.</i> , <b>28</b> , 9734 (1989).



Application	Product	Reference
Monoclonal antibodies— separation of different classes	Hydroxyapatite	Mahoney, C. W. Q., et al., <i>J. Biol. Chem.</i> , <b>2265</b> , 5424(1990).
Monoclonal antibody affinity chromatography	Affi-Gel 10 gel	Hammerberg, B., et al., <i>J. Immunol.</i> , <b>143</b> , 42901(1989).
Monoclonal antibody purification	Affi-Gel 10 gel	Hsu, Y., et al., <i>Proc. Natl. Acad. Sci. USA</i> , <b>81</b> , 2107 (1984); Theodos, C. M., et al., <i>J. Immunol.</i> , <b>144</b> , 4011 (1990).
	Affi-Gel protein A column	Dueweke, T. J. and Gennis, R. B., <i>J. Biol. Chem.</i> , <b>265</b> , 4273 (1990).
	Protein A MAPS buffers	Gogol, E. P., et al., <i>Biochem.</i> , <b>28</b> , 4717 (1989).
	DEAE Affi-Gel blue gel	Fung, S. K-K, et al., <i>Biochem</i> , <b>29</b> , 2657 (1990); Bruck, C., et al., <i>Methods Enzymol.</i> , <b>121</b> , 587-596 (1986).
Monoclonal antibody purification from ascites	DEAE Affi-Gel blue gel	Wildgoose, P., et al., <i>Biochem.</i> , <b>29</b> , 3413 (1990).
Muscle protein separation	Hydroxyapatite	Suzuki, A., et al., <i>J. Biol. Chem.</i> , <b>251</b> , 6860 (1976).
Nucleic acid base composition determination	Hydroxyapatite	Miyazawa, Y. and Thomas, Jr., C. A., <i>Mol. Biol.</i> , <b>11</b> , 223 (1965).
Peptide purification	Bio-Rex 70 resin	Wilson, S. P., <i>J. Neurosci. Methods</i> , <b>15</b> , 155 (1985).
Phosphoprotein separation	Hydroxyapatite	Addeo, F., et al., <i>J. Dairy Res.</i> , <b>44</b> , 63 (1977); Donnelly, W. J., <i>J. Dairy Res.</i> , <b>44</b> , 63 (1977).
Polypeptide purification from <i>Croatalus atrox</i> venom	Bio-Rex 70 resin	Hamilton, S. L. et al., <i>Science</i> , <b>229</b> , 182 (1985).
Protein concentration	Hydroxyapatite	Tiselius, A., et al., <i>Arch. Biochem. Biophys.</i> , <b>65</b> , 132 (1956).
Rhodamine removal from rhodamine-conjugated antibodies	Bio-Beads SM-2 beads	Spack, et al., <i>Anal. Biochem.</i> , <b>158</b> , 233 (1986).
Topoisomerase I purification	Hydroxyapatite	Hertzberg, R. P., et al., <i>Biochem.</i> , <b>28</b> , 4629 (1989).
Topoisomerase purification	Hydroxyapatite	Saijo, M., et al., <i>Biochem.</i> , <b>29</b> , 583 (1990).







# Desalting and Buffer Exchange

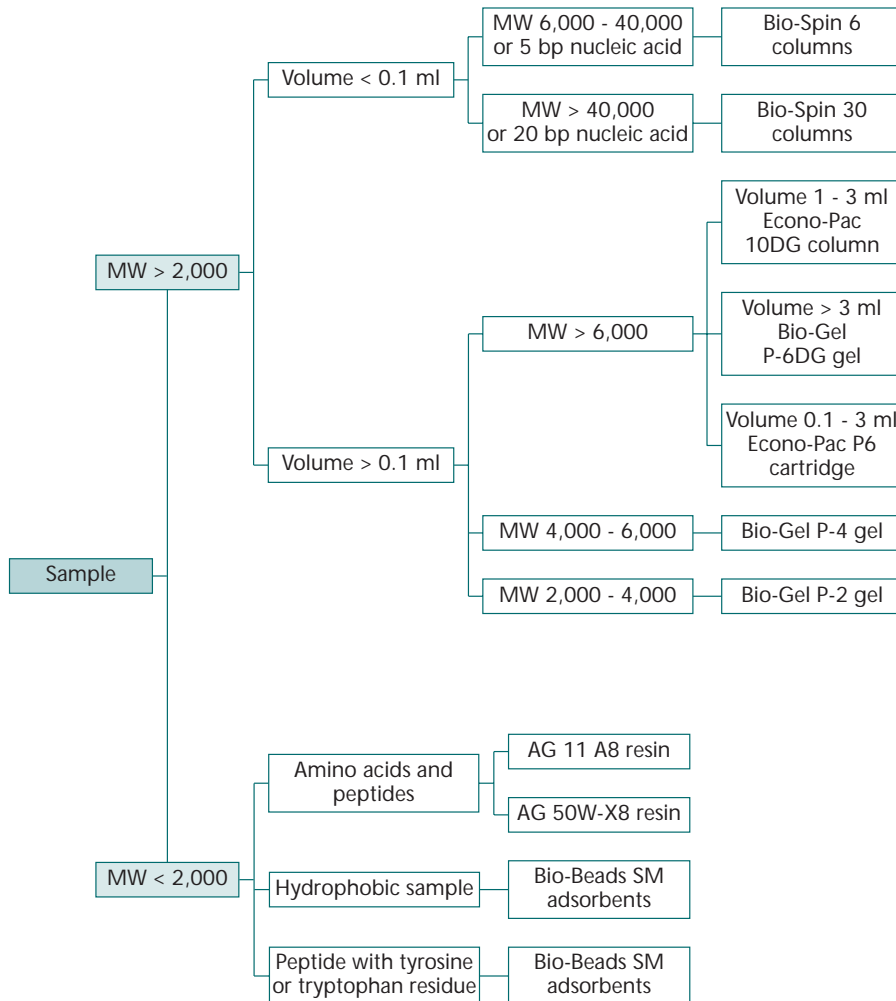

Table 2.1. Guide to Desalting and Buffer Exchange

## Introduction

Desalting and buffer exchange are often required in order to perform many analytical assays or for the next step in a purification scheme. Dialysis, the most common technique for desalting and buffer exchange can be very time consuming.



A more desirable alternative for desalting and buffer exchange is gel filtration. This method is as effective as exhaustive dialysis in far less time. Other desalting and buffer exchange methods include ion retardation, adsorption, and ion exchange chromatography. The method to be used for salt removal or buffer exchange depends on the properties of the sample, its molecular weight, and the volume to be desalted. Table 2.1 can help you select among the products available for desalting and buffer exchange.

## Methods

### MW > 2,000 Daltons (Gel Filtration)

Desalting and buffer exchange of samples with molecular weights greater than 2,000 daltons is easily accomplished using Bio-Gel P polyacrylamide gel filtration media. In gel filtration chromatography, small molecules enter the pores of the gel and are retained, while large molecules are excluded from the pores and eluted in the void volume. In this way salts, including buffer salts, are separated from larger molecules such as proteins and nucleic acids. Bio-Gel P gels are available in several particle size ranges with exclusion limits ranging from 1,800 to 100,000 daltons. Bio-Gel P-2, P-4, and P-6 gels are excellent for removing salts from samples containing biomolecules larger than 1,800, 4,000, and 6,000 daltons, respectively. Bio-Gel P gels are available in bulk for self-packing or in convenient prepacked columns and cartridges. Bio-Spin 6 and 30 columns are recommended for small sample volumes (< 100  $\mu$ l). These columns combine gel filtration and centrifugation to provide rapid, convenient desalting while minimizing sample dilution. For samples larger than 100  $\mu$ l, self-packed or prepacked Econo-Pac 10DG columns and Econo-Pac P6 cartridges are recommended. These columns can desalt samples up to 3 ml in minutes (Figure 2.1 and 2.2).

### MW < 2,000 Daltons (Ion Exchange and Adsorption)

Ion retardation, ion exchange, and adsorption chromatography are extremely useful techniques for desalting and buffer exchange applications when the biomolecules to be desalted are smaller than 2,000-4,000 daltons. Small amphoteric molecules, such as amino acids and peptides, can be desalted using AG 11 A8 ion retardation resin or AG 50W-X8 cation exchange resin. AG 11 A8 resin is used for desalting and buffer exchange of amphoteric compounds up to 4,000 daltons, while AG 50W-X8 ion exchange resin is used for desalting cationic compounds up



to a molecular weight of 1,000 daltons. AG 50W-X8 resin is especially useful for amino acid samples, and is the resin of choice when the sample is in acetate or citrate buffer. AG 50W-X8 resin should not be used for hydrophobic compounds because they will non-specifically adsorb to the resin matrix. AG 50W-X8 resin is available in several particle size ranges and in prefilled Poly-Prep columns for added convenience. Bio-Beads SM adsorbents are ideal for desalting hydrophobic compounds and are recommended for desalting peptides containing tyrosine or tryptophan residues.

**Conditions**

Column: Econo-Pac 10DG desalting column  
 Sample: Bovine serum albumin in 250 mM NaCl, 3.0 ml  
 Eluant: H<sub>2</sub>O  
 Flow rate: 1.0 ml/min  
 Peaks: 1. BSA, 2. NaCl

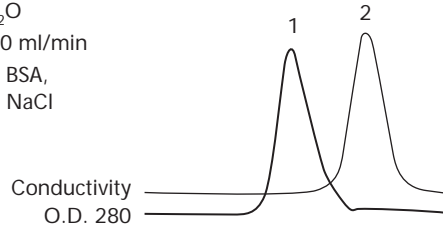

Fig. 2.1. Protein desalting with the Econo-Pac 10DG desalting column.

**Conditions**

Column: Econo-Pac 10DG desalting column  
 Sample: <sup>125</sup>I labeled follicle stimulating hormone, 3.0 ml  
 Eluant: H<sub>2</sub>O  
 Flow rate: 1.0 ml/min  
 Peaks: 1. <sup>125</sup>I labeled FSH, 2. <sup>125</sup>I (unincorporated)

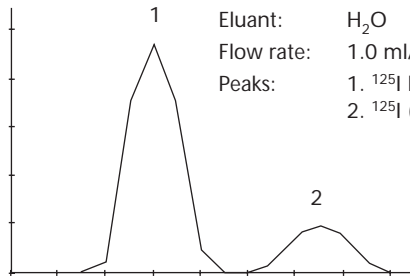

Fig. 2.2. Separation of radiolabeled protein from unincorporated radiolabel.



## References

Application	Product	Reference
Desalting amino acids	AG 50W-X8 cation exchange resin	Sato, M. and Yagi, K., <i>J. Chromatog.</i> , <b>242</b> , 185 (1982).
Desalting amino acids and peptides	AG 11 A8 ion retardation resin	Heathcote, J. G., <i>et al.</i> , <i>Clin. Chem. Acta.</i> , <b>32</b> , 457 (1971).
Desalting	AG 1-X4 resin	Turco, S. J. and Pickard, J. L., <i>J. Biol. Chem.</i> , <b>257</b> , 8674 (1982).
	AG 50W-X2 resin	Nakamura, T., <i>et al.</i> , <i>J. Biol. Chem.</i> , <b>265</b> , 5390 (1990).
	AG 50W-X4 resin	Esmon, B., <i>et al.</i> , <i>J. Biol. Chem.</i> , <b>259</b> , 10322 (1984).
	Bio-Gel P-2 gel	Faure, G., <i>et al.</i> , <i>Biochem.</i> , <b>22</b> , 2068 (1983); Garipey, J. and Hodges, R. S., <i>Biochem.</i> , <b>22</b> , 1586 (1983); Gatineau, E., <i>et al.</i> , <i>Biochem.</i> , <b>29</b> , 6480 (1990); Kehry, M. R., <i>et al.</i> , <i>Biochem.</i> , <b>21</b> , 5415 (1982); Knibbs, R. N., <i>et al.</i> , <i>Biochem.</i> , <b>28</b> , 6379 (1989); Loganathan, D., <i>et al.</i> , <i>Biochem.</i> , <b>29</b> , 4362 (1990); McKinney, J. D., <i>et al.</i> , <i>Anal. Chem.</i> , <b>55</b> , 91 (1983); Murakami, K., <i>et al.</i> , <i>Biochem.</i> , <b>21</b> , 5488 (1982); Matsumiya, M. and Otake, S., <i>Bull. Jpn. Soc Fish</i> , <b>52</b> , 1617 (1986); Van Pelt, J. E. and Northrop, D. B., <i>Arch. Biochem. Biophys.</i> , <b>230</b> , 250 (1984).
	Bio-Gel P-6 gel	Walsh, M. T., <i>et al.</i> , <i>Biochem.</i> , <b>29</b> , 6 (1990); Keller, J. W., <i>et al.</i> , <i>J. Biol. Chem.</i> , <b>265</b> , 5531 (1990).



# Plasmid Purification and Probe Clean-up

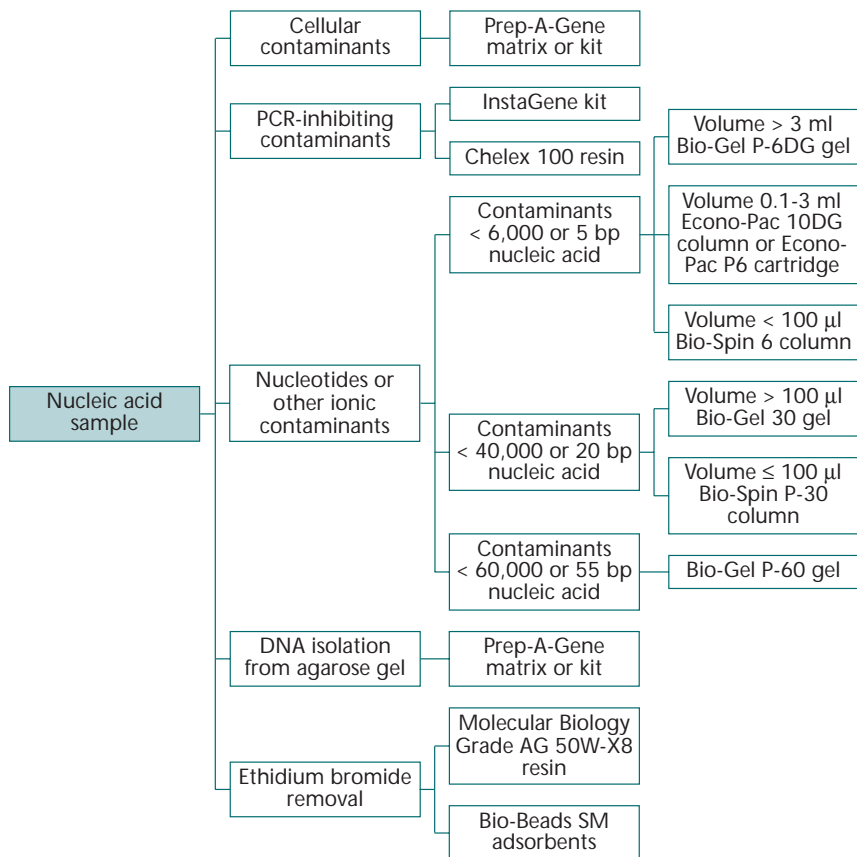

Table 3.1. Guide to Plasmid Purification and Probe Clean-up

## Introduction

It is often necessary to separate plasmid DNA from cell lysates or compounds such as unincorporated nucleotides, unincorporated linkers, and ethidium bromide, or to remove radiolabel or perform buffer exchange on nucleic acids and oligonucleotides. Table 3.1 can help you select among the products available for plasmid, oligonucleotide, and probe purification.



# Applications

## Ethidium Bromide and Propidium Iodide Removal

The intercalating dye reagents, ethidium bromide and propidium iodide, are commonly used to visualize single- and double-stranded nucleic acids. The presence of these dyes may inhibit restriction enzyme function, transformation efficiencies, and other applications utilizing DNA and RNA. AG 50W-X8 ion exchange resin is useful for removing both ethidium bromide and propidium iodide after use. The fluorescent labeled nucleic acid is simply passed over a column of the AG 50W-X8 resin, which removes the dye, and the pure preparation is collected in the void volume. Alternatively, ethidium bromide can be removed from nucleic acid preparations using Bio-Beads SM adsorbents.

## DNA Isolation from Agarose Gel

The Prep-A-Gene DNA purification matrix provides an easy, efficient method for recovering DNA from agarose gels. The novel matrix can be used to extract, purify, and concentrate DNA in less than 20 minutes. In a simple procedure, DNA is bound to the matrix while contaminants are washed away. The DNA is subsequently eluted from the matrix, yielding recoveries in excess of 85%. The purified DNA can be used for transformation, restriction enzyme digestion, ligation, and sequencing procedures. The Prep-A-Gene matrix is available separately or in convenient Prep-A-Gene DNA purification kits which include the binding, wash, and elution buffers.

## Radioactive Label Removal

The removal of unincorporated radioactive label is often required in nucleic acid experiments or is necessary to prevent interference in subsequent assays. For example, unincorporated radioactive label removal is very important to determine the labeling efficiency of a labeling reaction. Also DNA free of unincorporated label is required when the DNA is to be used as markers for gel electrophoresis, as substrates for enzymatic reactions, or as probes for hybridization. Bio-Rad offers several alternatives for radiolabel removal including gel filtration and adsorption chromatography. Gel filtration chromatography using Bio-Spin columns is ideal for removing unincorporated nucleotides. Separation occurs as the small nucleotide molecules are retained in the pores of the gel while the larger DNA molecules are eluted in the elution volume. These prepacked columns are quality-control



certified to insure a high recovery of DNA and a high retention of unincorporated nucleotides. Bio-Spin 6 columns are suitable for the purification of nucleic acids greater than ~ 5 bp in length, while Bio-Spin 30 columns are best suited for nucleic acids greater than ~ 20 bp in length. Bio-Gel P gel is also available in bulk, prepacked cartridges, and Econo-Pac 10DG columns for larger sample volumes. Alternatively, the Prep-A-Gene DNA purification kit efficiently removes nucleoside triphosphates from radiolabeling reactions. DNA binds to the matrix while the unincorporated nucleotide triphosphates do not. The unincorporated label is washed away with other reaction components and the DNA is subsequently eluted in a purified, concentrated form. Finally, nucleotides can also be concentrated using Bio-Beads SM-2 or SM-7 adsorbents.

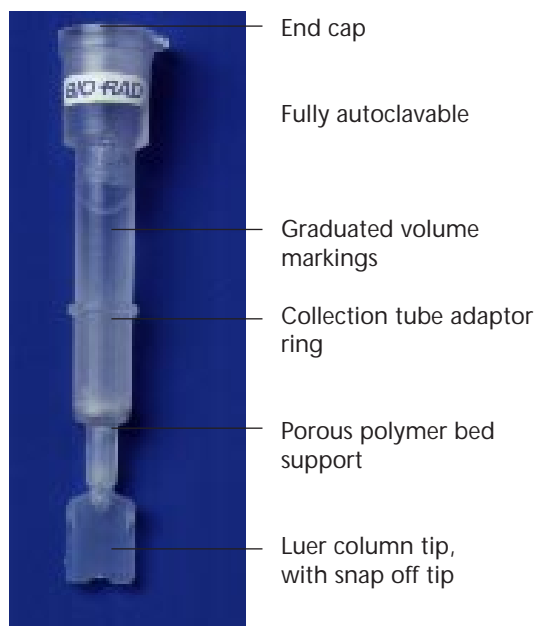

*Bio-Spin columns.*

## Plasmid Purification

Methods for plasmid purification include adsorption, size exclusion, and ion exchange chromatography. Bio-Rad offers the following products for plasmid purification.



Prep-A-Gene DNA or plasmid purification kits provide a fast and efficient means for DNA purification. The kits provide everything necessary for the purification and concentration of DNA > 200 bp. Using a batch technique, DNA is adsorbed onto the silica-like matrix, and RNA, protein, and other cellular components are washed away. The purified DNA is then eluted using elution buffer and is recovered in a form immediately available for use in cloning protocols. Using the Prep-A-Gene matrix and the GS Gene Prep manifold, 24 single-strand DNA (M13, phagemid) samples can be purified for nucleotide sequence analysis from phage supernatants in 45 minutes. Up to 24 double-strand DNA (plasmid) samples can be purified for either restriction enzyme analysis or nucleotide sequence analysis from cleared bacterial lysates in 2 hours.

Ion exchange chromatography is yet another method for plasmid purification. Plasmids can be purified using the Macro-Prep Q support without the need for cesium chloride gradients or phenol/chloroform extractions. This method produces plasmid DNA of the purity necessary for restriction enzyme digests, ligation reactions, and transformation protocols (Figures 3.1 and 3.2). The Macro-Prep Q support is available in convenient Econo-Pac cartridges in both 1 ml and 5 ml sizes.

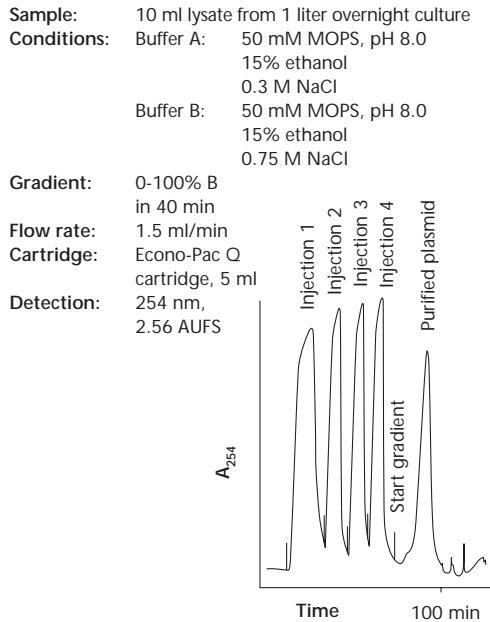

Fig. 3.1. Purification of pUC19 using Econo-Pac Q cartridge.

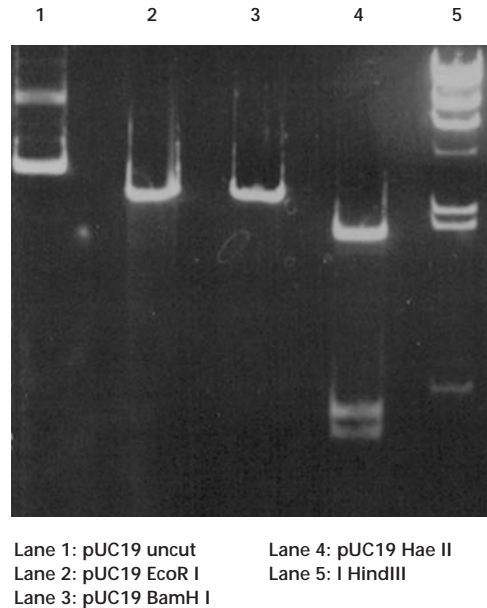

Fig. 3.2. Verification of plasmid purity. 1% agarose gel of 0.5 ng pUC 19 purified with Econo-Pac Q cartridge.



## Removal of PCR Inhibiting Contaminants

The InstaGene kit provides convenience and dependability in removing PCR-inhibiting components from genomic DNA preparations prior to PCR amplification. The unique matrix binds contaminants of the PCR procedure while the DNA remains in solution. A simplified protocol eliminates phenol/chloroform extractions and deproteinization steps. The kit is functionally tested to insure its ability to provide a useful DNA template for PCR amplification. Biotechnology grade Chelex 100 resin can also be used in DNA preparations prior to PCR amplification, however, the resin is not functionally tested for this application.

## References

Application	Product	Reference
cDNA size fractionation	Bio-Gel A-50m gel	Giese, K. and Subramanian, A. R., <i>Biochem.</i> , <b>28</b> , 3525 (1989).
Chromatin fragment purification	Bio-Gel A-50m gel	Jin, Y. J. and Cole, R. D., <i>J. Biol. Chem.</i> , <b>261</b> , 3420 (1986).
Chromatin isolation	Bio-Gel A-0.5m gel	Prevelige, Jr., P. E. and Fasman, G. D., <i>Biochem.</i> , <b>26</b> , 2944 (1987).
DNA fragment purification	Bio-Gel P-60 gel	Schmidel, D. K., <i>et al.</i> , <i>Biochem.</i> , <b>29</b> , 7845 (1990).
DNA preparation for PCR amplification	Chelex 100 resin	Walsh, P. S., <i>et al.</i> , <i>BioTechniques</i> , <b>10</b> , 506 (1991).
Ethidium bromide removal	AG 50W-X8 resin	Maniatis, T., Fritsch, E.F. and Sambrook, J. <i>Molecular Cloning: A Laboratory Manual</i> , Cold Spring Harbor Laboratory (1982).
	Bio-Beads SM adsorbents	Joshua, H., <i>BioTechniques</i> , <b>4</b> , 207 (1986); Lunn, G. and Sansone, E. B., <i>Biotechnic and Histochemistry</i> , <b>66</b> , 307 (1991).
Isolation and purification plasmid DNA	Bio-Gel A gel	Rachubinski, R. A., <i>et al.</i> , <i>Proc. Nat. Acad. Sci. USA</i> , <b>82</b> , of 3973 (1985).
Labeled DNA recovery	Bio-Gel P-60 gel	Shoubridge, E. A., <i>et al.</i> , <i>Cell</i> , <b>62</b> , 43 (1990).
Labeled RNA separated from ATP	Bio-Gel P-2 gel	Blum, B. and Simpson, L., <i>Cell</i> , <b>62</b> , 391 (1990).
Linear duplex DNA sample extraction	Bio-Gel A-15m gel	Colowick, S. P. and Kaplan, N. O., <i>Meth. Enzymol.</i> , <b>68</b> , 43 (1980).
Oligomer desalting	Bio-Gel P-2 gel	Krug, M., <i>et al.</i> , <i>Biochem.</i> , <b>21</b> , 4713 (1982).
Oligomer fractionation	Bio-Gel P-2 gel	Keller, K. M., <i>et al.</i> , <i>Biochem.</i> , <b>28</b> , 8100 (1989).
Oligonucleotide clean-up	Bio-Gel P-6DG gel	England, T. E. and Uhlenbeck, O. C., <i>Biochem.</i> , <b>17</b> , 2069 (1978).



Application	Product	Reference
Oligonucleotide desalting	Bio-Gel P-100 gel	Hogrefe, H. H., <i>et al.</i> , <i>J. Biol. Chem.</i> , <b>265</b> , 5561 (1990).
	Econo-Pac 10DG desalting columns	Fischer, I., <i>et al.</i> , <i>BioTechniques</i> , <b>9</b> , 300 (1990).
Oligonucleotide purification	Bio-Gel P-60 gel	Conner, G. E., <i>et al.</i> , <i>Biochem.</i> , <b>28</b> , 3530 (1989).
	Bio-Gel P-6DG gel	Ramsing, N. B., <i>et al.</i> , <i>Biochem.</i> , <b>28</b> , 9528 (1989).
	Chelex resin	Kochoyan, M., <i>et al.</i> , <i>Biochem.</i> , <b>29</b> , 4799 (1990).
	Hydroxyapatite	Grohmann, K., <i>et al.</i> , <i>Biochem.</i> , <b>14</b> , 1961 (1975).
Plasmid purification	Prep-A-Gene DNA purification kit	Willis, E. H., <i>BioTechniques</i> , <b>9</b> , 92 (1990)
Propidium iodide removal	AG 50W-X8 resin	Rodrigues, R. L., and Tait, R. C., <i>Recombinant DNA Techniques: An Introduction</i> , Addison-Wesley Publishing Co., Reading, Massachusetts, 153-158 (1983).
	Bio-Beads SM adsorbents	Lunn, G. and Sansone, E. B., <i>Biotechnic and Histochemistry</i> , <b>66</b> , 307 (1991).



# Detergent Removal

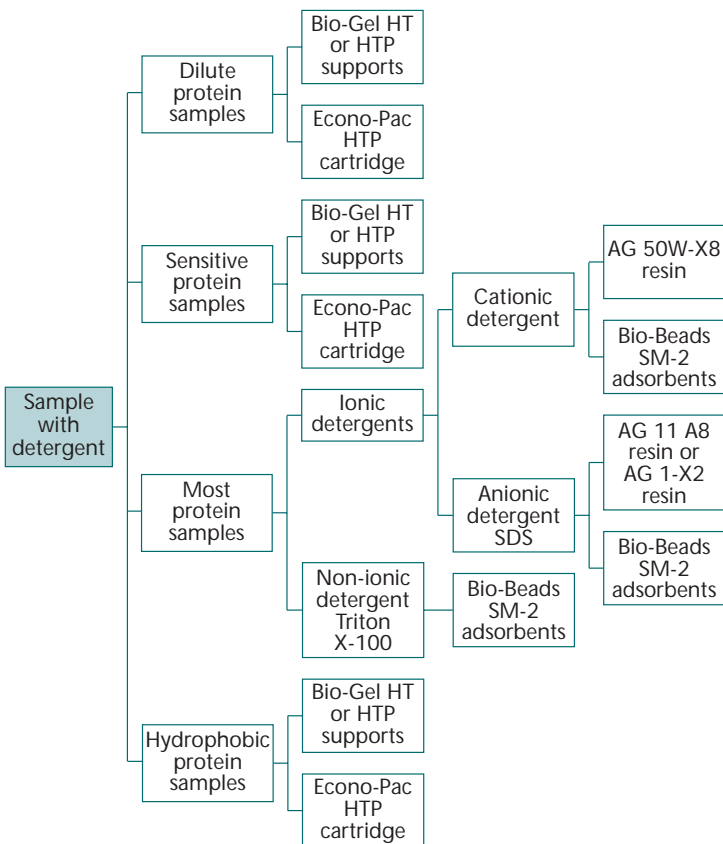

Table 4.1. Guide to Detergent Removal

## Introduction

Detergents are used to solubilize proteins in many purification protocols and analytical assays. It then becomes necessary to remove the detergents due to their interference with subsequent procedures. In some cases, detergents interfere with protein analysis and quantitation. Detergent molecules are amphiphilic molecules consisting of a hydrophobic “tail” and a hydrophilic “head”. The hydrophilic head may contain either ionic or nonionic chemical structures. The type of detergent and the stability or sensitivity of the protein present in the sample determines the optimal detergent removal method.



# Methods

## Non-Ionic Detergents

Hydrophobic interaction chromatography with Bio-Beads SM-2 beads is ideal for removing non-ionic detergents such as Triton X-100, NP-40, Tween-20, and octylglucoside. The hydrophobic beads adsorb the hydrophobic tail of the detergent for easy removal. Removal can be accomplished by either batch or column methods and the beads can be used in aqueous solutions or with a variety of solvents.

## Ionic Detergents

Ion exchange chromatography is recommended for the removal of ionic detergents. Ion exchange resins are available to remove either cationic or anionic detergents. AG 11 A8 ion retardation resin provides a rapid and efficient method for removing anionic detergents such as SDS from proteins. AG 50W-X8 strong cation exchange resin is recommended for removing cationic detergents from protein samples. Alternatively, Bio-Beads SM-2 adsorbents can be used to remove ionic detergents from small sample volumes. As with non-ionic detergent removal, the hydrophobic tail of the ionic detergent is adsorbed by the hydrophobic beads.

## Sensitive or Dilute Protein Samples

Hydroxyapatite is recommended for removing detergents from samples containing sensitive enzymes or other proteins which may be affected by exposure to ion exchange resins. Hydroxyapatite is particularly useful with dilute protein solutions. Protein binds to the hydroxyapatite support, while the detergent is unretained. The protein is subsequently eluted from the column.



## References

Application	Product	Reference
Detergent dialysis	Bio-Beads SM-2 beads	Wang, C-Y. and Huang, L., <i>Biochem.</i> , <b>28</b> , 9508 (1989).
Detergent removal	Bio-Beads SM-2 beads	Ator, M. A., <i>et al.</i> , <i>Biochem.</i> , <b>28</b> , 9633 (1989); Shayiq, R. M. and Avadhani, N. G., <i>Biochem.</i> , <b>29</b> , 866 (1990)
	Hydroxyapatite	Marcus, C. B., <i>et al.</i> , <i>Biochem.</i> , <b>24</b> , 5115 (1985).
Detergent removal, NP-40	Bio-Beads SM-2 beads	Momoi, T., <i>Biochem. Biophys. Res. Commun.</i> , <b>87</b> , 541 (1979); Verkman, A. S., <i>et al.</i> , <i>Biochem.</i> , <b>28</b> , 4240 (1989).
Detergent removal, C <sub>12</sub> E <sub>8</sub>	Bio-Beads SM-2 beads	Levy, D., <i>et al.</i> , <i>Biochem.</i> , <b>29</b> , 9480 (1990).
Detergent removal, cholate	Bio-Beads SM-2 beads	Bonomo, E. A. and Swaney, J. B., <i>J. Lipid Research</i> , <b>29</b> , 380 (1988); Bonomo, E. A. and Swaney, J. B., <i>Biochem.</i> , <b>29</b> , 5094 (1990); Jinks, D. C. and McElhane, R. N., <i>Anal. Biochem.</i> , <b>164</b> , 331 (1987).
Detergent removal, deoxycholate	Bio-Beads SM-2 beads	Horigome, T. and Sugano, H., <i>Anal. Biochem.</i> , <b>130</b> , 393 (1983); Lorusso, D. J. and Green, F. A., <i>Science</i> , <b>188</b> , 66 (1974); Shechter, I. and Bloch, K., <i>J. Biol. Chem.</i> , <b>246</b> , 7690 (1971); Garland, R. C. and Cori, C. F., <i>Biochem.</i> , <b>11</b> , 4712 (1972).
Detergent removal, Emulgen 911	Bio-Beads SM-2 beads	Gibson, G. G. and Schenkman, F. B., <i>J. Biol. Chem.</i> , <b>253</b> , 5957 (1978); Warner, M., <i>J. Biol. Chem.</i> , <b>257</b> , 12995 (1982).
Detergent removal, Emulgen 913	Hydroxyapatite	Nguyen, L. B., <i>et al.</i> , <i>J. Biol. Chem.</i> , <b>265</b> , 4541 (1990).
Detergent removal, Emulphogene BC-720	Bio-Beads SM-2 beads	Brunch, R. C., <i>J. Biol. Chem.</i> , <b>261</b> , 9450 (1986).
Detergent removal, Octylglucoside	Bio-Beads SM-2 beads	Novick, S. L. and Baldeschwieler, J. D., <i>Biochem.</i> , <b>27</b> , 7919 (1988).
Detergent removal, SDS	AG 11 A8 resin	Young, D. H., <i>et al.</i> , <i>Appl. Environ. Microbiol.</i> , <b>50</b> , 605 (1985).
	AG 1-X2 resin	Weber, K. and Kuter, D. J., <i>J. Biol. Chem.</i> , <b>246</b> , 4504 (1971).
	Bio-Gel P-4 gel	Millett, F., <i>et al.</i> , <i>Biochem.</i> , <b>22</b> , 546 (1983).
SDS from proteins	AG 11 A8 resin	Kapp, O. H. and Vinogradov, S. N., <i>Anal. Biochem.</i> , <b>91</b> , 230 (1978).
Detergent removal, sodium cholate	Hydroxyapatite	Nguyen, L. B., <i>et al.</i> , <i>J. Biol. Chem.</i> , <b>265</b> , 4541 (1990).



Application	Product	Reference
Detergent removal, Triton X-100	Bio-Beads SM-2 beads	Bonomi, F. and Kurtz, D., <i>Anal. Biochem.</i> , <b>142</b> , 226 (1984); Bonomo, E. A. and Swaney, J. B., <i>J. Lipid Research</i> , <b>29</b> , 380 (1988); Braun, P., <i>et al.</i> , <i>Biochem.</i> , <b>29</b> , 10376 (1990); Drexler, G., <i>et al.</i> , <i>J. Immunol. Methods</i> , <b>95</b> , 117 (1986); Holloway, P. W., <i>Anal. Chem.</i> , <b>53</b> , 304 (1973); Metsikko, K., <i>et al.</i> , <i>EMBO Journal</i> , <b>5</b> , 3429 (1986); Welling, G. W., <i>et al.</i> , <i>J. Chromatog.</i> , <b>297</b> , 101 (1984).
Detergent removal, Tween-20	Bio-Beads SM-2 beads	Lamphear, B. J. and Panniers, R., <i>J. Biol. Chem.</i> , <b>265</b> , 5333 (1990).



# Ionic Contaminant Removal

## Introduction

Ionic contaminant removal is an important sample preparation step prior to analysis or purification of compounds. Applications vary from general protocols for buffer deionization and metal ion removal to unique applications for removal of specific ionic contaminants. Bio-Rad products for ionic contaminant removal include anion exchange resins, cation exchange resins, mixed bed resins, and ion retardation resins.

## Deionization

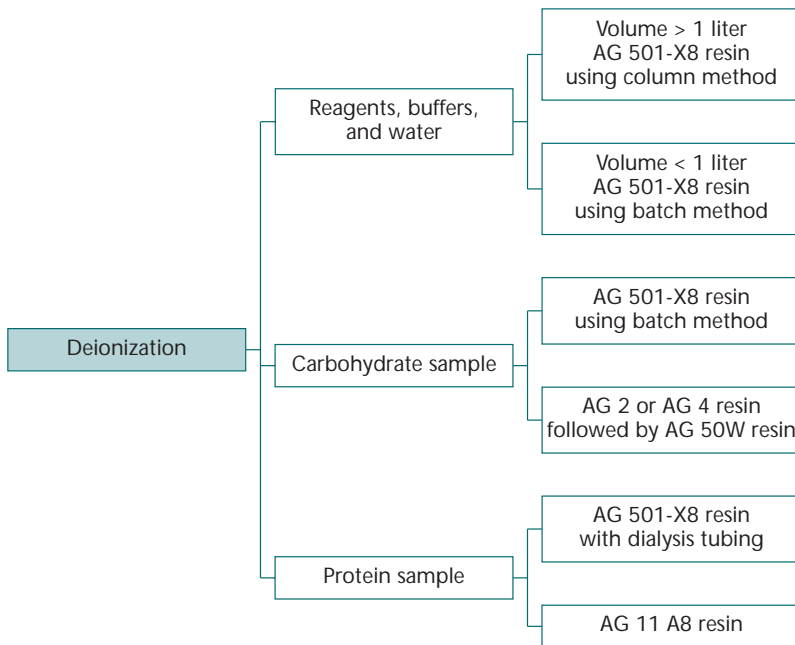

Table 5.1. Guide to Deionization

Typical deionization applications include deionization of carbohydrates, separation of unincorporated label from a labeled sample, removal of ionic contaminants from protein solutions, and deionization of other reagents such as water, formamide, acrylamide, urea, and glyoxal. Table 5.1 lists products for specific deionization applications.





## Mechanism

AG 501-X8 mixed bed resins are specifically designed for deionization protocols. Mixed bed resins consist of equivalent amounts of strong cation and strong anion exchange resins, in their respective hydrogen and hydroxyl forms. Deionization is achieved by exchanging solute cations for hydrogen and solute anions for hydroxyl, with the resulting neutralization yielding water.

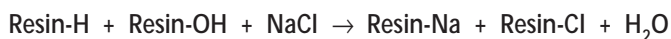

The separation mechanism of the AG 11 A8 resin is ionic adsorption rather than conventional ion exchange. The AG 11 A8 resin contains strong anion exchange groups and weakly acidic cation exchange groups which retard ions as they pass through a column. Adsorbed salts move down the column during water elution because the fixed exchange groups compete with the mobile salt ions to become self-adsorbed.

## Methods

Deionization may be achieved by either batch or column methods. With the batch method, the resin is added directly into the solution to be deionized, followed by stirring to achieve deionization. The column method requires preparing a chromatography column and pouring the solution to be deionized over the column. The results shown in Table 5.2 demonstrate that the column method provides higher purity in less time. However, the batch method is more commonly used, since it provides reagents of acceptable quality and is more convenient.

Table 5.2. Batch vs Column Deionization of Urea with Mixed Bed Resin

	Batch	Column
Sample	100 ml 6 M urea	100 ml 6 M urea
Starting conductivity	70 $\mu\text{mho/cm}$	70 $\mu\text{mho/cm}$
Amount of AG 501-X8 resin	5 g	5 g
Final conductivity	5.0 $\mu\text{mho/cm}$	0.2 $\mu\text{mho/cm}$
Time	5 hours	10 minutes



## Applications

### **Reagents, buffers, and water**

Reagent preparation applications include deionization of water and other non-ionic solutions. AG 501-X8 mixed bed resins are recommended for complete deionization of non-electrolyte solutions. The batch method provides a convenient way to deionize electrophoresis reagents. The procedure was originally described by Maniatis<sup>1</sup> for deionization of formamide, but can be used for other non-ionic reagents such as urea, glyoxal, and acrylamide. Generally, for reagent preparation applications, the batch method is recommended for sample sizes of less than 1 liter and the column method is recommended for sample sizes in excess of 1 liter.

### **Protein samples**

Protein samples can be deionized using AG 501-X8 mixed bed resins. However, care must be taken to eliminate non-specific binding of hydrophobic proteins to the resin matrix. Non-specific binding of protein is of special concern when protein concentrations are low or when protein samples are very valuable. Non-specific binding may be eliminated by placing the mixed bed resin in dialysis tubing to prevent direct contact between the protein and the resin.

### **Carbohydrate samples**

Carbohydrate samples are also deionized using AG 501-X8 mixed bed resins. Non-specific adsorption of carbohydrates and polyhydric alcohols can be minimized by using a batch technique and removing the resin from the carbohydrate solution immediately following deionization. Alternatively, tandem columns of AG 2-X8 and AG 50W-X8 resin can be used to remove ions from carbohydrates, dextrans, and polyhydric alcohols. Additionally, sucrose, fructose, and glucose are successfully deionized with AG 4-X4 and AG 50W-X8 resins.

## References

Application	Product	Reference
Deionization	AG 50W-X2 resin	de Groot, H. J. M., <i>et al.</i> , <i>Biochem.</i> , <b>29</b> , 6873 (1990).
	AG 50W-X8 resin	Engelhard, M., <i>et al.</i> , <i>Biochem.</i> , <b>28</b> , 5432 (1989).
Acrylamide	AG 501-X8 resin	Seneor, D. F. and Ackers, G. K., <i>Biochem.</i> , <b>29</b> , 6568 (1990).
Carbohydrates	AG 2-X8 resin	Cullen, M. P., <i>et al.</i> , <i>J. Chromatog.</i> , <b>337</b> , 29 (1985).
Formamide	AG 501-X8 resin	Boime, I., <i>et al.</i> , <i>J. Biol. Chem.</i> , <b>251</b> , 820 (1976); Dozin, B., <i>et al.</i> , <i>Biochem.</i> , <b>24</b> , 5581 (1985); Jaeger, J. A., <i>et al.</i> , <i>Biochem.</i> , <b>29</b> , 10147 (1990); Maniatis, <i>et al.</i> , <i>Molecular Cloning: A Laboratory Manual</i> , Cold Spring Harbor Lab (1982); Nudel, U., <i>et al.</i> , <i>J. Biol. Chem.</i> , <b>252</b> , 2182 (1977); Ofengand, J. and Liou, R., <i>Biochem.</i> , <b>19</b> , 4814 (1980).
Lubrol-PX buffer	AG 501-X8(D) resin	Miller, J. A., <i>et al.</i> , <i>Biochem.</i> , <b>22</b> , 462 (1983); Moore, A. C., <i>et al.</i> , <i>Biochem.</i> , <b>21</b> , 6212 (1982).



Application	Product	Reference
Membrane	Dowex 50 resin	Dunach, M., <i>et al.</i> , <i>Biochem.</i> , <b>28</b> , 8940 (1989).
Peptide	Dowex 1 resin	Palczewski, K., <i>et al.</i> , <i>Biochem.</i> , <b>28</b> , 8764 (1989).
Urea	AG 1-X8 resin	Nelson, D. A., <i>et al.</i> , <i>Biochem.</i> , <b>21</b> , 4350 (1982); Senear, D. F. and Ackers, G. K., <i>Biochem.</i> , <b>29</b> , 6568 (1990).
N-ni-trisodiethanolamine	AG 50W-X8 resin	Wigfield, Y. Y. and Lanouette, M., <i>JAOAC</i> , <b>68</b> , 1142 (1985).

1. Maniatis, *et al.*, *Molecular Cloning: A Laboratory Manual*, Cold Spring Harbor Lab (1982).

## Metal Ion Removal

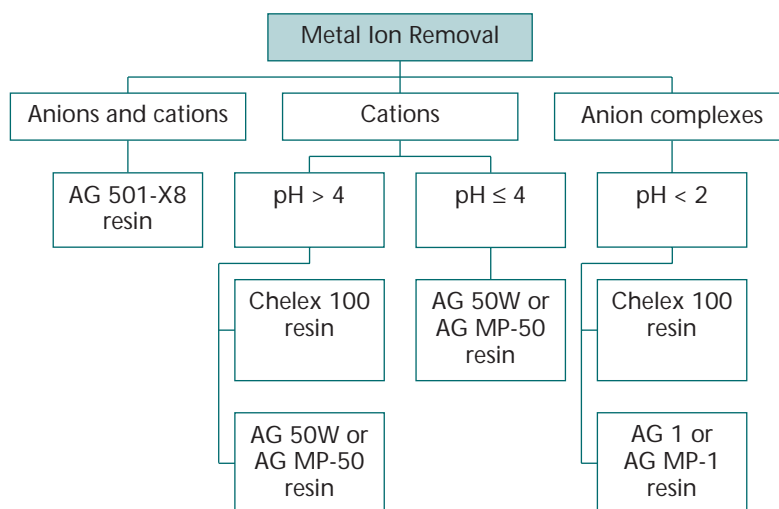

Table 5.3. Guide to Metal Removal

Ion exchange resins are the products of choice for metal concentration and removal. Many methods of trace metal analysis depend on the prior separation and concentration of metals from such samples as air, soil, industrial waste water, and biological extracts. Trace metals can be concentrated directly by adsorption to Chelex 100 chelating resin or AG 50W strong cation exchanger, or indirectly through the adsorption of metal-anion complexes on AG 1 strong anion exchange resin.

## Mechanism

In ion exchange chromatography, ions are adsorbed by electrostatic forces. Ions bind to cation and anion exchange resins according to specific selectivities. Alternatively, Chelex chelating resin contains paired iminodiacetate ions which act as chelating groups to bind polyvalent metal ions. Chelex has a high preference for heavy metals over monovalent cations and has a very strong attraction for transition metals. Any metal removed from solution is replaced by an equivalent amount of the resin's counterion.

### *Metal cations*

Chelex chelating resin has a high selectivity for polyvalent cations and is the preferred method for metal ion removal. Cation adsorption is very low at  $\text{pH} < 2$ , increases sharply from  $\text{pH} 2-4$ , and reaches a maximum at a  $\text{pH} > 4$ . Therefore, for cation removal, Chelex resin is recommended for use at  $\text{pH} > 4$ . AG 50W strong cation exchange resin can also be used for metal concentration, separation, and removal. However, the selectivity for transition metal cations is very high and elution is difficult.

### *Metal anion complexes*

The concentration or removal of metal-anion complexes can be achieved through adsorption on AG 1 anion exchange resin. Alternatively, Chelex 100 resin can be used to bind anion complexes, since it has been found to act as an anion exchanger at  $\text{pH} < 2$ .<sup>2</sup>

### *Metal cation and anion removal*

AG 501-X8 mixed bed resin can be used to remove metals and anionic metal complexes from solutions. Since AG 501-X8 mixed bed resin consists of equivalent amounts of AG 1-X8 strong anion exchange resin and AG 50W-X8 strong cation exchange resin, it is ideal for removing metals from solutions containing both anionic metal complexes and metal cations.

## Applications

### *Trace metal removal, concentration, and metal analysis*

Chelex resins' high affinities for copper, iron, and other heavy metals, as well as calcium and magnesium ions, make them uniquely suited for removing, concentrating, or analyzing trace metals in solutions, even when large amounts of sodium and potassium are present. The resins have been used for analysis of trace metals in natural waters, reagents, biochemicals, physiological fluids, culture media, soils, and enzyme systems. Trace metals can be concentrated by adsorption to Chelex chelating resin. The use of Chelex resin to pre-concentrate samples for analysis has been extensively reviewed.<sup>3</sup> Determination of subnanogram levels of Cd, Co, Cu, Fe, Mn, Ni, Pb, and Zn can be achieved using Chelex 100 resin.<sup>4</sup>



### **Buffer purification**

Chelex 100 resin is recommended for removal of heavy metal ion contaminants in buffers and reagents. It is a very powerful tool in the preparation of high purity buffers, since it has a very strong attraction for transition metals even in the presence of high salt concentrations.

## References

<b>Application</b>	<b>Product</b>	<b>Reference</b>
Boron clean-up	Chelex resin	Gregorie, D., <i>Anal. Chem.</i> , <b>59</b> , 2479 (1987).
C-reactive protein dialysis	Chelex resin	Kinoshita, C. M., <i>et al.</i> , <i>Biochem.</i> , <b>28</b> , 9840 (1989).
Calcium removal	Chelex resin	Putnam-Evans, C. L., <i>et al.</i> , <i>Biochem.</i> , <b>29</b> , 2488 (1990).
Calcium removal from sarcoplasmic reticulum vesicle	Chelex resin	Chiesi, M. and Inesi, G., <i>Biochem.</i> , <b>19</b> , 2912 (1980).
Calcium removal from whole blood (batch)	Chelex resin	Raymond, F. A. and Weinsilboum, R. M., <i>Clin. Chim. Acta</i> , <b>58</b> , 185 (1975).
Calmodulin purification	Chelex resin	Vorherr, T., <i>et al.</i> , <i>Biochem.</i> , <b>29</b> , 355 (1990).
Chelex competition assay	Chelex resin	Hutnik, C. M. L., <i>et al.</i> , <i>Biochem.</i> , <b>29</b> , 7318 (1990).
Disodium salt removal	Chelex resin	Ray, Jr., W. J., <i>et al.</i> , <i>Biochem.</i> , <b>29</b> , 2770 (1990).
Divalent cation removal	Chelex resin	Stewart, J. M. McD., <i>et al.</i> , <i>Biochem.</i> , <b>28</b> , 4695 (1989).
Divalent cation removal from stock solutions	Chelex resin	Devlin, C. C. and Grisham, C. M., <i>Biochem.</i> , <b>29</b> , 6192 (1990).
Equilibrium dialysis	Chelex resin	Thielens, N. M., <i>et al.</i> , <i>Biochem.</i> , <b>29</b> , 3570 (1990).
Heavy metal ion removal	Chelex resin	Anderson, V. E. and Cleland, W. W., <i>Biochem.</i> , <b>29</b> , 10498 (1990).
Heavy metal ion removal from buffer	Chelex resin	Wood, W. M., <i>et al.</i> , <i>Biochem.</i> , <b>24</b> , 3686 (1985).
Iron removal from buffer	Chelex resin	Bomford, A., <i>et al.</i> , <i>Biochem.</i> , <b>24</b> , 3472 (1985).
Lithium chloride purification	Chelex resin	Ray, Jr., W. J., <i>et al.</i> , <i>Biochem.</i> , <b>29</b> , 2770 (1990).
Metal analysis Cu, Cd, Mn, Zn, Pb from river water	Chelex resin	Liu, Y. and Ingle, Jr., J. D., <i>Anal. Chem.</i> , <b>61</b> , 525 (1989).
Metal analysis Cu, Cd, Zn from natural waters	Chelex resin	Liu, Y. and Ingle, Jr., J. D., <i>Anal. Chem.</i> , <b>61</b> , 520 (1989).
Metal removal	Chelex resin	Beyer, W. F., <i>et al.</i> , <i>Biochem.</i> , <b>28</b> , 4403 (1989); Graf, E., <i>J. Agric. Food Chem.</i> , <b>31</b> , 851 (1983); Sadhu, A. S. and Magnuson, J. A., <i>Biochem.</i> , <b>28</b> , 3197 (1989).
Pb removal	Chelex resin	Trost, J. T. and Blankenship, R. E., <i>Biochem.</i> , <b>28</b> , 9898 (1989).
Metal removal from ATP	Chelex resin	Sontheimer, G. M., <i>et al.</i> , <i>Biochem.</i> , <b>26</b> , 2701 (1987).



Application	Product	Reference
Metal removal from ATP sodium salt	Chelex resin	Avena, R. M. and Bowen, W. J., <i>J. Biol. Chem.</i> , <b>246</b> , 2265 (1971).
Metal removal from buffer	Chelex resin	Chung, H. K. and Ingle, Jr., J. D., <i>Anal. Chem.</i> , <b>62</b> , 2547 (1990); Laue, T. M., et al., <i>Biochem.</i> , <b>28</b> , 4762 (1989).
Metal removal from buffer biological samples	Chelex resin	Knapp, G., et al., <i>J. Anal. Atomic Spectrometry</i> , <b>2</b> , 611 and (1987).
Metal removal from enzyme preparations	Chelex resin	Barker, R., et al., <i>Biochem. J.</i> , <b>177</b> , 289 (1979); Dent, A. J., et al., <i>Biochem.</i> , <b>29</b> , 7822 (1990); Dunn, M. F., et al., <i>Biochem.</i> , <b>19</b> , 718 (1980).
Metal removal from S100b and melittin	Chelex resin	Baudier, J., et al., <i>Biochem.</i> , <b>26</b> , 2886 (1987).
Oligonucleotide purification	Chelex resin	Kochoyan, M., et al., <i>Biochem.</i> , <b>29</b> , 4799 (1990).
Paramagnetic impurities removed from oligonucleotides	Chelex resin	Kochoyan, M., et al., <i>Biochem.</i> , <b>29</b> , 4799 (1990).
PCR signal enhancement	Chelex resin	Singer-Sam, J., et al. Amplifications (Perkin Elmer Cetus) Issue 3 (1989).
Potassium chloride purification	Chelex resin	Burbaum, J. J. and Knowles, J. R., <i>Biochem.</i> , <b>28</b> , 9306 (1989).
Preirradiation separation mechanism	Chelex resin	Gokmen, I. G., et al., <i>Anal. Chem.</i> , <b>61</b> , 2757 (1989).
Protease inhibition	Chelex resin	Shogren, R., et al., <i>Biochem.</i> , <b>28</b> , 5525 (1989).
Protein dialysis	Chelex resin	Laue, T. M., et al., <i>Biochem.</i> , <b>28</b> , 4762 (1989).
Protein solution clean-up	Chelex resin	Kaarsholm, N. C., et al., <i>Biochem.</i> , <b>28</b> , 4427 (1989).
Reagent purification for NMR	Chelex resin	Brito, R. M. M., et al., <i>Biochem.</i> , <b>30</b> , 1461 (1991).
Sample preparation	Chelex resin	Schroeder, S. A., et al., <i>Biochem.</i> , <b>28</b> , 8292 (1989).
Sea water analysis	Chelex resin	Pai, S-C., et al., <i>Anal. Chem.</i> , <b>62</b> , 774 (1990).
Selenium determination in fat materials and petroleum products	Chelex resin	Narasaki, H., <i>Anal. Chem.</i> , <b>57</b> , 2481 (1985).
Trace metal extraction from seawater	Chelex resin	Paulson, A. J., <i>Anal. Chem.</i> , <b>58</b> , 183 (1986).
Trace metal separation	AG 50W-X4 resin	Van der Walt, T. N. and Strelow, F. W. E., <i>Anal. Chem.</i> , <b>55</b> , 212 (1983).
Transition metal separation	Chelex resin	Liu, Y. and Ingle, Jr., J. D., <i>Anal. Chem.</i> , <b>61</b> , 520 (1989); Liu, Y. and Ingle, Jr., J. D., <i>Anal. Chem.</i> , <b>61</b> , 525 (1989).
Uridine 5'-diphosphate chloroacetol synthesis	Chelex resin	Flentke, G. R. and Frey, P. A., <i>Biochem.</i> , <b>29</b> , 2430 (1990).
Vanadium in seawater	Chelex resin	Dupont, V., et al., <i>Anal. Chem.</i> , <b>63</b> , 520 (1991).



Application	Product	Reference
Vanadium separation from biological materials	Chelex resin	Fassett, J. D. and Kingston, H. M., <i>Anal. Chem.</i> , 57, 2474 (1985).
Water purification	Chelex resin	Grimshaw, C. E., <i>et al.</i> , <i>Biochem.</i> , 29, 9936 (1990).

2. El Sweify, F. H., Shabana, R., Abdel-Rahman, N. and Aly, H.F., *J. Radioanal. Nucl. Chem.*, 91 (1), 91 (1985).
3. Riley, J. P. and Skirrow, G., *Chemical Oceanography*, Vol 3, Academic Press, New York (1975).
4. Kingston, H. M., Barnes, I. L., Brady, T. J. and Rains, T. C., *Anal. Chem.*, 50, 2064 (1978).

## Anion and Cation Removal

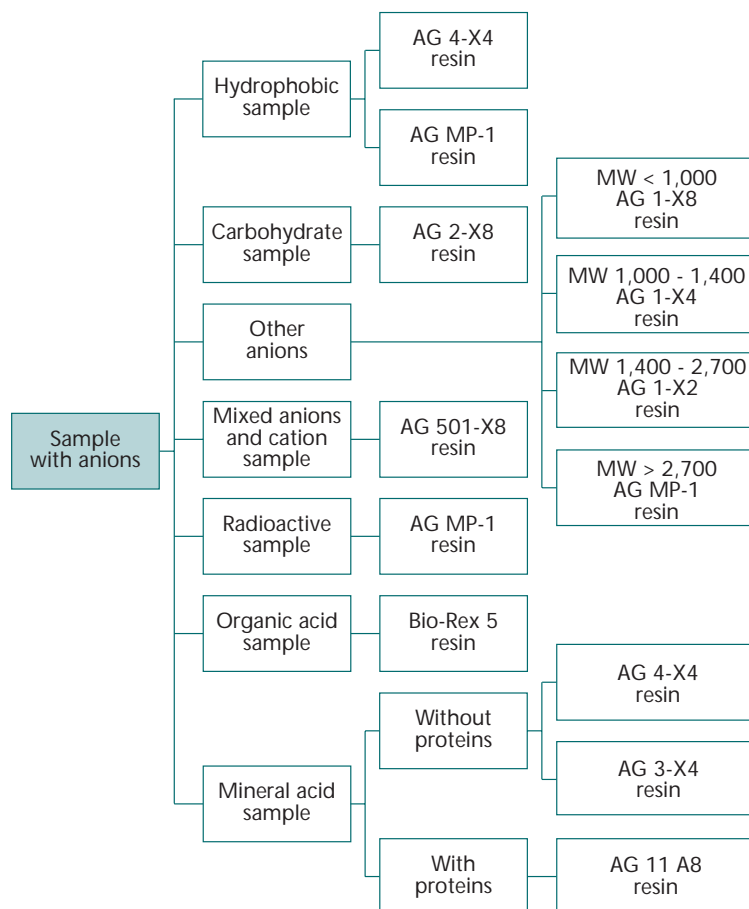
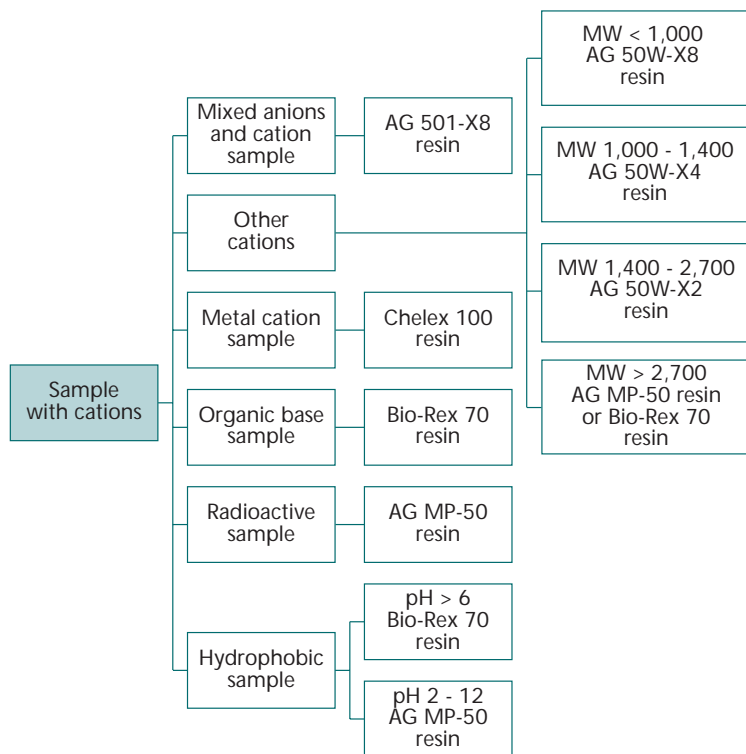

Table 5.4. Guide to Anion Removal



**Table 5.5. Guide to Cation Removal**

Ion exchange resins can be used to remove or concentrate molecules in a variety of samples (Tables 5.4 and 5.5). Applications of these resins range from inorganic ion removal to concentration of large proteins. In general, for zwitterionic compounds, a cationic molecule will be exchanged onto a cation exchanger if the pH is at least 1 unit below the *pI* of the cation, and an anion will be exchanged onto an anion exchanger if the pH is at least 1 unit above the *pI* of the anion. Inorganic ions will exchange for the counterion of the resin if the resin selectivity is higher than that of the counterion. Ion exchange resins allow concentration of dilute samples and isolation of compounds of interest from complex materials to be accomplished easily and inexpensively.

### Resin Selection Parameters

The following important parameters should be considered when selecting an ion exchange resin.





<b>pH</b>	The operative pH range determines which ion exchange resins can be used. Strong anion exchangers such as AG 1, AG 2, and Macro-Prep high Q resins exchange ions at any pH from 1–14, as do strong cation exchangers, like AG 50W, AG MP 50, and Macro-Prep high S resins. Conversely, weak cation exchangers, like Bio-Rex 70 and Macro-Prep CM supports, function as cation exchangers only when their functional groups are ionized (pH > 5). Weak anion exchange resins such as AG 3-X4 and AG 4-X4 resins also only work when their functional groups are protonated (pH < 7). When selecting a resin for a particular sample, check the pH to confirm that the resin functional groups and the sample are oppositely charged. A zwitterionic compound will be anionic if the pH is at least 1 unit above its pI and cationic if the pH is 1 unit below its pI.
<b>Ionic form</b>	The ionic form (counterion) of a resin is the ion presently adsorbed by the resin. The selectivity of the ion to be exchanged (the sample) must be higher than that of the counterion of the resin. The relative selectivity of various ions is shown in Table 5.6. If the selectivity of an ion is not known, success can be assured by selecting the most reactive form of resin; e.g. AG 1 resin in the OH <sup>-</sup> form or AG 50W resin in the H <sup>+</sup> form.
<b>Porosity</b>	The porosity of a support refers to the total pore volume within the matrix of the support. The greater the pore volume, the greater the porosity. A very porous support may have either many small pores or few large pores. Porous supports with high exclusion limits are recommended for high molecular weight compounds such as proteins and other biomolecules. Low porosity supports are recommended for low molecular weight compounds such as inorganic ions and organic acids. Bio-Rad's high porosity supports include Macro-Prep, Bio-Gel, and Bio-Rex 70 supports. Less porous resins include AG, Dowex, and Chelex resins.
<b>Particle size</b>	Ion exchange resins are available in several particle size ranges. Large particle size ranges such as 300-1,180 μm, or 20-50 mesh, are recommended for batch techniques because they are easiest to remove from the sample. For column techniques, particle selection is very important and depends on the column size. In general, the 38-75 μm particle size (200-400 mesh) is recommended for columns less than 1 ml, 75-150 μm (100-200 mesh) for columns up to 10 ml, 150-300 μm (50-100 mesh) for columns up to 30 ml, and 300-1,180 μm (20-50 mesh) for larger columns.
<b>Time and temperature</b>	For column applications, a minimum retention time of 1–2 minutes is necessary for ion exchange to occur. In batch applications, ion exchange continues for up to 24 hours, but for most sample preparation applications 30-60 minutes is sufficient. Ion exchange applications can be performed between 4–85 °C.



Table 5.6. Relative Selectivity of Various Counterions on AG Resins

AG 50W-X8 resin		AG 1-X8 resin	
Counterion	Relative Selectivity	Counterion	Relative Selectivity
H <sup>+</sup>	1.0	OH <sup>-</sup>	1.0
Li <sup>+</sup>	0.85	F <sup>-</sup>	1.6
Na <sup>+</sup>	1.5	Propionate	2.6
NH <sub>4</sub> <sup>+</sup>	1.95	Acetate	3.2
Mn <sup>+2</sup>	2.35	Formate	4.6
K <sup>+</sup>	2.5	HPO <sub>4</sub> <sup>-</sup>	5.0
Mg <sup>+2</sup>	2.5	IO <sub>3</sub> <sup>-</sup>	5.5
Fe <sup>+2</sup>	2.55	HCO <sub>3</sub> <sup>-</sup>	6.0
Rb <sup>+</sup>	2.6	Cl <sup>-</sup>	22
Cs <sup>+</sup>	2.7	NO <sub>2</sub> <sup>-</sup>	24
Zn <sup>+2</sup>	2.7	BrO <sub>3</sub> <sup>-</sup>	27
Co <sup>+2</sup>	2.8	HSO <sub>3</sub> <sup>-</sup>	27
Cu <sup>+2</sup>	2.9	CN <sup>-</sup>	28
Cd <sup>+2</sup>	2.95	Br <sup>-</sup>	50
Ni <sup>+2</sup>	3.0	NO <sub>3</sub> <sup>-</sup>	65
Ca <sup>+2</sup>	3.9	ClO <sub>3</sub> <sup>-</sup>	74
Sr <sup>+2</sup>	4.95	HSO <sub>4</sub> <sup>-</sup>	85
Cu <sup>+</sup>	5.3	Phenate	110
Hg <sup>+2</sup>	7.2	I <sup>-</sup>	175
Pb <sup>+2</sup>	7.5	Citrate	220
Ag <sup>+</sup>	7.6	Salicylate	450
Ba <sup>+2</sup>	8.7	Benzene-sulfonate	500

## Applications

### *Ampholyte removal*

Ampholytes are amphoteric molecules used in isoelectric focusing. Since AG 501-X8 mixed bed resin has both anion and cation exchange capabilities, it is ideal for removing carrier ampholytes of either positive or negative net charge. Additionally, mixed bed resins can quantitatively remove carrier ampholytes from protein fractions or separate ampholytes from peptides with a molecular weight greater than 4,000 daltons.



<b>Organic acids</b>	Low molecular weight anionic molecules such as organic acids are removed using AG 1-X8 resin. The resin has an approximate molecular weight exclusion limit of 1,000 daltons and is ideal for removing, concentrating, or separating low molecular weight molecules.
<b>Peptides and amino acids</b>	Since peptides and amino acids are amphoteric compounds, they can be concentrated or separated using either AG 1 strong anion exchange resins or AG 50W strong cation exchange resins. The <i>pI</i> of the molecule and the operating pH will determine which ion exchange resin to use. Generally, at $\text{pH} > \text{pI}$ an anion exchange resin is used, and at a $\text{pH} < \text{pI}$ , a cation exchange resin is used. The lower crosslinked resins have higher exclusion limits and are recommended for high molecular weight molecules like peptides. Similarly, the higher crosslinked resins have lower exclusion limits and are recommended for low molecular weight molecules like amino acids.
<b>Sugars and sugar alcohols</b>	Sugars and sugar alcohols are optimally deionized using AG 2-X8 strong anion exchange resin. The resin is similar to AG 1 resin but is capable of deionizing sugars without isomerization. A stepwise gradient and borate buffers can be used to separate the sugars.

## References

Application	Product	Reference
Acetylglutamate from glutamate separation	AG 50W-X8 resin	Alonso, E. and Rubio, V., <i>Anal. Biochem.</i> , <b>146</b> , 252 (1985).
Acylcarnitine purification	AG 1-X8 resin	Shinka, T., <i>et al.</i> , <i>Kanazawa Ika Daigaku Zasshi</i> , <b>13</b> , 238 (1988).
Adenine nucleotides in blood	AG MP-1 resin	Hsu, D. S. and Chen, S. S., <i>J. Chromatog.</i> , <b>311</b> , 396 (1984).
Adenosine mannoheptose isolation	Dowex 1-X4 resin	Kocsis, B. and Kontrohr, T., <i>J. Biol. Chem.</i> , <b>259</b> , 11858 (1984).
Adenosyl-L-methionine separation	AG 50W-X4 resin	Miura, G. A. and Chiang, D. K., <i>Anal. Biochem.</i> , <b>147</b> , 217 (1985).
Aldehyde and ketone separation	AG 50W-X2 resin	Rendina, A. R. and Cleland, W. W., <i>Anal. Biochem.</i> , <b>117</b> , 213 (1981).
Aldehyde separation	AG 1-X8 resin	Christofferson, K., <i>Anal. Chim. Acta.</i> , <b>33</b> , 285 (1965); LaNoue, K., <i>et al.</i> , <i>J. Biol. Chem.</i> , <b>245</b> , 102 (1970).
Alpha-ketoisocaproic acid desalting	AG 11 A8 resin	Barrio, J. R., <i>et al.</i> , <i>J. Nucl. Med.</i> , <b>24</b> , 515 (1983).
Aluminum concentration	AG 1-X8 resin	Pesavento, M., <i>et al.</i> , <i>Analyst.</i> , <b>114</b> , 623-626, (1989).



Application	Product	Reference
Amine concentration	AG 1-X8 resin	Minkler, P. E., <i>et al.</i> , <i>J. Chromatog.</i> , <b>336</b> , 271 (1984).
Amine measurement in CNS samples	AG 1-X4 resin AG 3-X4 resin Bio-Rex 70 resin	Smith, J. E., <i>et al.</i> , <i>Anal. Biochem.</i> , <b>64</b> , 149 (1975).
Amine separation	AG 50W-X8 resin	Charest, R. and Dunn, A., <i>Anal. Biochem.</i> , <b>136</b> , 421 (1984).
Amino acid concentration	AG 50W-X8 resin	Ford, C. W., <i>J. Sci. Food Agric.</i> , <b>35</b> , 881 (1984); Stabler, S. P., <i>et al.</i> , <i>Anal. Biochem.</i> , <b>162</b> , 185 (1987).
Aminocyclopropane carboxylic acid separation	AG 50W-X4 resin	Miura, G. A. and Chiang, D. K., <i>Anal. Biochem.</i> , <b>147</b> , 217 (1985).
Ammonia determination in plasma	AG 50W-X8 resin	Forman, D. T., <i>Clin. Chem.</i> , <b>10</b> , 497 (1964).
Ammonium isocyanate removal from urea	AG 501-X8 resin	Busse, W. and Carpenter, F. H., <i>Biochem.</i> , <b>15</b> , 1649 (1976); Edelstein, C., <i>et al.</i> , <i>Biochem.</i> , <b>15</b> , 1262 (1976); Spieker, H. and Polet, H., <i>J. Biol. Chem.</i> , <b>251</b> , 987 (1976); Traugh, J. A. and Porter, G. G., <i>Biochem.</i> , <b>15</b> , 610 (1976).
Ampholyte Removal	AG 501-X8 resin	Bakker, J.A., <i>et al.</i> , <i>J. Chromatog.</i> , <b>209</b> , 273, (1981); Baumann, G. and Crambach, A., <i>Anal. Biochem.</i> , <b>69</b> , 649 (1975); Brown, W.D., and Green, S., <i>Anal. Biochem.</i> , <b>34</b> , 593 (1975).
Anion removal from porphyrin in urine	AG 1-X8 resin	Torben, K. and Penderson, J. S., <i>Scan. J. Clin. Lab. Invest.</i> , <b>38</b> , 279 (1978).
ATP clean-up	Dowex 1-X8 resin	England, P. J., <i>Anal. Biochem.</i> , <b>93</b> , 272 (1979).
ATP from F-actin solution	AG 1 resin	Chock, S. P., <i>et al.</i> , <i>Biochem.</i> , <b>15</b> , 3246 (1976).
ATP purity determination	Dowex 1-X8 resin	Hausman, S. Z., <i>et al.</i> , <i>Biochem.</i> , <b>29</b> , 6128 (1990).
ATP removal from proteoliposomes	AG 1-X8 resin	Woldegiorgis, G. and Shrago, E., <i>J. Biol. Chem.</i> , <b>260</b> , 7585 (1985).
Boron clean-up	AG 50W-X8 resin Chelex resin	Gregorie, D., <i>Anal. Chem.</i> , <b>59</b> , 2479 (1987).
Bound micrococcal nuclease removal	AG 50W-X2 resin	Goel, S. B. and Modak, S. P., <i>Nucleic Acids Res.</i> , <b>12</b> , 1391 (1984).
Carbohydrate deionization	AG 2-X8 resin AG 50W-X8 resin	Cullen, M. P., <i>et al.</i> , <i>J. Chromatog.</i> , <b>337</b> , 29 (1985).
Carbohydrate removal	AG 1-X8 resin	Marescau, B., <i>et al.</i> , <i>J. Chromatog.</i> , <b>377</b> , 334 (1986).
Carboxylated pepsinogen purification	AG 1-X8 resin	Rajagopalan, T. G., <i>et al.</i> , <i>J. Biol. Chem.</i> , <b>241</b> , 4940 (1966).
Carnitine clean-up	AG 1-X8 resin	Minkler, P. E., <i>et al.</i> , <i>J. Chromatog.</i> , <b>336</b> , 271 (1984).
Cation removal from sulfate	AG 50W-X8 resin	Hoffer, E. M., <i>et al.</i> , <i>Atmospheric Environment</i> , <b>13</b> , 303 (1979).
Chloride uptake of liposomes determination	Dowex 1-X8 resin	Verkman, A. S., <i>et al.</i> , <i>Biochem.</i> , <b>28</b> , 4240 (1989).



Application	Product	Reference
Creatine kinase isoenzyme separation (batch)	AG MP-1 resin	Morin, L. G., <i>Clin. Chem.</i> , <b>22</b> , 92 (1976).
Crystalline uric acid preparation	AG 2-X8 resin	Johnson, L. A. and Emmerson, B. T., <i>Clin. Chim. Acta.</i> , <b>41</b> , 389 (1972).
Cyclic AMP from cGMP phosphodiesterase separation	AG MP-1 resin	Hsu, D. S. and Chen, S. S., <i>J. Chromatog.</i> , <b>245</b> , 369 (1982).
Cyclic AMP from cGMP separation	AG 1-X8 resin	Fallon, A. M. and Wyatt, G. R., <i>Anal. Biochem.</i> , <b>63</b> , 614 (1975); Kuehl, Jr., F.A., <i>et al.</i> , <i>Proc. Natl. Acad. Sci. USA</i> , <b>71</b> , 1866 separation (1974).
Cyclic AMP purification	Dowex 50W-X8 resin	Nemecek, G. M., <i>et al.</i> , <i>J. Biol. Chem.</i> , <b>254</b> , 598 (1979).
Cyclic nucleotide extraction	AG 1-X8 resin	Schwartzel, Jr., E. H., <i>et al.</i> , <i>Anal. Biochem.</i> , <b>78</b> , 395 (1977)
	AG 50W-X8 resin	Kuo, W., <i>et al.</i> , <i>J. Biol. Chem.</i> , <b>248</b> , 2705 (1973); Schwartz, D. P., <i>et al.</i> , <i>J. Biol. Chem.</i> , <b>248</b> , 2699 (1973).
Cysteinyldopamine from dicysteinyldopamine	AG 50W-X2 resin	Ito, S. and Fujita, K., <i>J. Chromatog.</i> , <b>375</b> , 134 (1986).
Desformylgramicidin purification	AG MP-50 resin	Rottenberg, H. and Koeppe, II, R. E., <i>Biochem.</i> , <b>28</b> , 4361 (1989).
Diaminopimelate from lysine separation	AG 50W-X8 resin	Kelland, J. G., <i>et al.</i> , <i>Biochem.</i> , <b>24</b> , 3263 (1985).
Diethyl acetal purification	AG 50W-X8 resin	Cho, Y. K., <i>et al.</i> , <i>Biochem.</i> , <b>27</b> , 3320 (1988).
DNA A protein separation from <i>E. coli</i>	Bio-Rex 70 resin	Sekimizu, K., <i>et al.</i> , <i>J. Biol. Chem.</i> , <b>263</b> , 7136 (1988).
Dopamine hydrochloride concentration	AG 50W-X12 resin	Miller, S. M. and Klinman, J. P., <i>Biochem.</i> , <b>24</b> , 2114 (1985).
Ethidium bromide removal from plasmids	AG 50W-X8 resin	Rodrigues, R. L. and Tait, R. C., <i>Recombinant Techniques—An Introduction</i> , Addison-Wesley (1983).
Fatty acid removal from lipids	AG 1-X8 resin	Goodridge, A. G., <i>J. Biol. Chem.</i> , <b>248</b> , 4318 (1973).
Free inositol removal from bound inositol	Dowex 1-X8 resin	Grier III, C. E. and Mastro, A. M., <i>J. Immunol.</i> , <b>141</b> , 2585 (1988).
GABA aminotransferase assay	AG 50W-X8 resin	Silverman, R. B. and George, C., <i>Biochem.</i> , <b>27</b> , 3285 (1988).
Gentamicin purification from serum	Bio-Rex 70 resin	Habbal, Z. M., <i>Clin. Chim. Acta</i> , <b>95</b> , 301 (1979).
Glucose from gluconic acid separation	AG 1-X8 resin	Marshall, L. M. and Appiah, A., <i>J. Chromatog.</i> , <b>73</b> , 257 (1972).
Glucose, sucrose, and fructose extraction	AG 4 resin: AG 50W resin	Salem, <i>et al.</i> , <i>J. Chromatog. Sci.</i> , <b>28</b> , 250-253 (1990).
Glutamic acid purification	Dowex 50 resin	MacKenzie, S. L. and Tenaschuk, J., <i>J. Chromatog.</i> , <b>322</b> , 228 (1985).



Application	Product	Reference
Glycine purification	AG 50W-X8 resin	Arkowitz, R. A. and Abeles, R. H., <i>Biochem.</i> , <b>28</b> , 4639 (1989).
Glycopeptide and oligosaccharide purification	AG 50W-X2 resin	Nishikawa, Y., <i>et al.</i> , <i>J. Biol. Chem.</i> , <b>263</b> , 8270 (1988).
Glyphosate quantitation	AG 1-X8 resin Dowex 50W-X8 resin	Thompson, D., <i>et al.</i> , <i>JAOAC</i> , <b>72</b> , 355 (1989).
Heptose nucleotide concentration	Dowex 1-X8 resin	Kocsis, B. and Kontrohr, T., <i>J. Biol. Chem.</i> , <b>259</b> , 11858 (1984).
<sup>125</sup> I cleanup	AG 50W-X8 resin	Aufmkolk, M., <i>et al.</i> , <i>J. Biol. Chem.</i> , <b>261</b> , 11623 (1986).
IDP purification	Dowex 1 resin	Kawakita, N. and Yamazaki, M., <i>Biochem.</i> , <b>17</b> , 3546 (1978).
Inorganic phosphorous oxo-anion separation	AG 1-X8 resin	Nakamura, T., <i>et al.</i> , <i>J. Chromatog.</i> , <b>161</b> , 421 (1978).
Inositol phosphate determination	AG 1-X8 resin	McCoy, K. L., <i>et al.</i> , <i>J. Immunol.</i> , <b>143</b> , 29 (1989).
Inositol phosphate formation	AG 1-X8 resin	Berridge, M. J., <i>et al.</i> , <i>J. Biochem.</i> , <b>212</b> , 473 (1983).
Inositol phosphate isolation	AG 1-X8 resin	Grier III, C. E. and Mastro, A. M., <i>J. Immunol.</i> , <b>141</b> , 2585 (1988); Heathers, G.P., <i>et al.</i> , <i>Anal. Biochem.</i> , <b>176</b> , 109 (1989); Trenn, G., <i>et al.</i> , <i>J. Immunol.</i> , <b>142</b> , 3796 (1989).
	Dowex 1-X8 resin	Stanley, J. B., <i>et al.</i> , <i>J. Immunol.</i> , <b>142</b> , 3546 (1989).
Inositol phosphate separation	AG 1 resin	Smith, C. D., <i>et al.</i> , <i>J. Biol. Chem.</i> , <b>262</b> , 6121, (1987).
Inositol removal	Dowex 1-X8 resin	Trenn, G., <i>et al.</i> , <i>J. Immunol.</i> , <b>142</b> , 3796 (1989).
L-tryptophan purification	Dowex 50W-X2 resin	Yoshida, R., <i>et al.</i> , <i>J. Immunol.</i> , <b>141</b> , 2819 (1988).
Lipase purification	AG MP-1 resin	Baillargeon, M. W. and McCarthy, S. G., <i>Lipids</i> , <b>26</b> , 831-836.
Malate removal from proteoliposomes	AG 1-X8 resin	Kaplan, R. S. and Pedersen, P. L., <i>J. Biol. Chem.</i> , <b>260</b> , 10293 (1985).
Maleic and fumaric acid separation	AG 50W-X4 resin	Richards, M., <i>J. Chromatog.</i> , <b>115</b> , 259 (1975).
Metal absorption measurement, zinc	AG 1-X8 resin	Eagles, J., <i>et al.</i> , <i>Anal. Chem.</i> , <b>61</b> , 1023 (1989).
Metal concentration	AG 1-X8 resin	Porta, V., <i>et al.</i> , <i>Mikrochim. Acta.</i> , <b>3</b> , 247-255 (1989).
	AG MP-1 resin; Bio-Beads SM-2 beads	Abollino, O., <i>et al.</i> <i>Anal. Chem.</i> , <b>62</b> , 21-16, (1990).
Methylmalonic acid purification	AG 3-X4 resin	Giorgia, A. J. and Plaut, G. W. E., <i>J. Lab. and Clin. Med.</i> , <b>66</b> , 667 (1985).
Monosaccharide clean-up-cation removal	AG 50W-X8 resin	Ochiai, M., <i>J. Chromatog.</i> , <b>194</b> , 224 (1980).



Application	Product	Reference
N-acetyl-L-[ <sup>35</sup> S]Met purification	AG 50W resin	Martin, D. J. and Rubenstein, P. A., <i>J. Biol. Chem.</i> , <b>262</b> , 6350 (1987).
Neutral metabolite isolation	AG 1-X8 resin; AG 50W-X8 resin	Terry, R. C. and Simon, M., <i>J. Chromatog.</i> , <b>232</b> , 261 (1982).
Niacin concentration	AG 1-X8 resin	Tyler, T. A. and Shrago, R. R., <i>J. Liq. Chromatog.</i> , <b>3</b> , 269 (1980).
Nitrite determination in meat	AG 50W-X12 resin	Kordorouba, V. and Pelletier, M., <i>Mitt. Geb. Lebensmittelunters. Hyg.</i> , <b>79</b> , 90 (1988).
Nucleic acid base separation from photoproducts	Dowex 1-X8 resin	Salter, L. F. and Thomas, R. C., <i>Biomed. Chromatog.</i> , <b>3</b> , 32 (1989).
Nucleic acid separation	AG 1-X8 resin	Heldt, H. W., <i>et al.</i> , <i>Anal. Biochem.</i> , <b>101</b> , 278 (1980).
Nucleic acid stripping	AG 50W-X2 resin	Chandrasekaran, E. V., <i>et al.</i> , <i>Prep. Biochem.</i> , <b>5</b> , 281 (1975).
Nucleoside mono-, di-, and triphosphate separation	AG 50W-X4 resin	Leigh, C. P. H. and Cashion, P. J., <i>J. Chromatog.</i> , <b>192</b> , 490 (1980).
Nucleoside purification	AG 1-X2 resin	Higashi, K., <i>et al.</i> , <i>Biochim. Biophys. Acta.</i> , <b>262</b> , 320 (1972); Tsiftoglou, A. S. and Georgatsos, J. G., <i>Biochim. Biophys. Acta.</i> , <b>262</b> , 239 (1972);
Nucleoside separation	AG 1-X2 resin  AG 1-X4 resin	Asteriadis, G. T., <i>et al.</i> , <i>Anal. Biochem.</i> , <b>70</b> , 64 (1976); Kuo, K. C., <i>et al.</i> , <i>J. Chromatog.</i> , <b>378</b> , 361 (1986).  Asteriadis, G. T., <i>et al.</i> , <i>Anal. Biochem.</i> , <b>70</b> , 64 (1976).
Nucleotide cleanup	AG 50W-X4 resin	DeCamp, D. L., <i>et al.</i> , <i>Biochem.</i> , <b>27</b> , 7651 (1988).
Nucleotide separation from nucleoside	AG 1-X8 resin	Deutscher, M., <i>J. Biol. Chem.</i> , <b>247</b> , 469 (1972).
Oligogalacturonic acids	AG MP-1 resin	Doner, L.W., <i>et al.</i> , <i>J. Chromatog.</i> , <b>449</b> , 229 (1988).
Oligonucleotide separation	AG 1-X2 resin; AG 1-X4 resin	Asteriadis, G. T., <i>et al.</i> , <i>Anal. Biochem.</i> , <b>70</b> , 64 (1976).
Oligouronide fractionation	AG 1-X8 resin	Dave, B. A., <i>et al.</i> , <i>J. Chromatog.</i> , <b>116</b> , 395 (1976).
Organic acid concentration	AG 1-X8 resin	Chen, P. M., <i>et al.</i> , <i>J. Amer. Soc. Hort. Sci.</i> , <b>107</b> , 807 (1982).
Oxo-L-proline separation from proline	AG 50W-X8 resin	Seddon, A. P. and Meister, A., <i>J. Biol. Chem.</i> , <b>261</b> , 11538 (1986).
Peptide cleanup	Dowex 1-X2 resin; Dowex 50W-X2 resin	Schiffmann, E., <i>et al.</i> , <i>J. Immunol.</i> , <b>114</b> , 1831 (1975).
Perindoprilate separation	AG 1-X2 resin	van den Berg, H., <i>et al.</i> , <i>J. Pharm. Biomed. Anal.</i> , <b>9</b> , 517-524, (1991).
Phosphate mixtures in detergents	AG 1-X8 resin	Lundgren, D. P. and Loeb, N. P., <i>Anal. Chem.</i> , <b>33</b> , 366 (1961).
Phosphatidylinositol hydrolysis	AG 1-X8 resin	Wilson, D. B., <i>et al.</i> , <i>J. Biol. Chem.</i> , <b>259</b> , 11718 (1984).
Phosphoinositide metabolism	AG 1-X8 resin	Oron, Y., <i>et al.</i> , <i>Nature</i> , <b>313</b> , 141 (1985).



Application	Product	Reference
Phytate concentration	AG 1-X8 resin	Ellis, R. and Morris, E. R., <i>Cereal Chem.</i> , <b>63</b> , 58 (1986).
Phytic acid concentration	AG 1-X4 resin	Matsunaga, A., <i>et al.</i> , <i>Shokuhin Eiseigaku Zasshi</i> , <b>29</b> , 408 (1988).
Phytic acid determination	AG 1-X8 resin	Graf, E. and Dintzis, F. R., <i>J. Agric. Food. Chem.</i> , <b>30</b> , 1094 (1982).
Pi recovery from glucose-6 phosphate	AG 1-X4 resin	Stroop, S. D. and Boyer, P. D., <i>Biochem.</i> , <b>24</b> , 2204 (1985).
Picric acid from protein hydrolysates	AG 1 resin	Smith, J. E., <i>et al.</i> , <i>Anal. Biochem.</i> , <b>64</b> , 149 (1975).
Picric acid removal	AG 1-X8 resin	Rajagopalan, T. G., <i>et al.</i> , <i>J. Biol. Chem.</i> , <b>241</b> , 4940 (1966).
Proline concentration	Bio-Rex 70 resin	Larson, A. A. and Dalo, N. L., <i>J. Chromatog.</i> , <b>375</b> , 37 (1986).
Propidium iodide removal	AG 50W-X8 resin	Rodrigues, R. L. and Tait, R. C., <i>Recombinant Techniques—An Introduction</i> , Addison-Wesley (1983).
Retinoic acid concentration	AG 1-X2 resin	Tamarin, A., <i>et al.</i> , <i>J. Embryol. Exp. Morph.</i> , <b>84</b> , 1056 (1984).
Serum thyroxine determination	AG 2-X8 resin	Murphy, B. V. and Jachan, C., <i>J. Lab. and Clin. Med.</i> , <b>66</b> , 161 (1965).
Sugar and acid isolation from apples	AG 1-X8 resin; AG 50W-X8 resin	Lee, H. S. and Wrolstad, R. E., <i>JAOAC</i> , <b>71</b> , 795 (1988).
Sulfamethazine concentration	AG MP-1 resin	Schwartz, D. P., <i>JAOAC</i> , <b>68</b> , 214 (1985).
Sulfated N-acylhexosamine	AG 1-X8 resin	Nowakowski, R. W., <i>Biochem. Int.</i> , <b>22</b> , 419-426, (1990). separation
Sulfated proteoglycan purification	AG 1-X8 resin	Babu, P. B. and Sudhakaran, P. R., <i>J. Cell Biochem.</i> , <b>46</b> , 48-53, (1991).
Sulfathiazole concentration	AG MP-1 resin	Schwartz, D. P. and Sherma, J., <i>JAOAC</i> , <b>69</b> , 72 (1986).
Taurine clean-up	Dowex 2-X8 resin Dowex 50W-X8 resin	Stephan, Z. F., <i>et al.</i> , <i>J. Biol. Chem.</i> , <b>262</b> , 6069 (1987).
Taurine purification	AG 1-X8 resin AG 50W-X8 resin	Porter, D. W., <i>et al.</i> , <i>J. Chromatog.</i> , <b>454</b> , 311 (1988).
Thyroid hormone removal from serum	AG 1-X8 resin	Stanley, F., <i>et al.</i> , <i>J. Biol. Chem.</i> , <b>261</b> , 9400 (1966).
Tricarboxylic acid separation	AG 1-X8 resin	Bengtsson, L. and Samuelson, O., <i>Anal. Chim. Acta</i> , <b>44</b> , 217 (1969).
Triiodide removal	AG MP-1 resin	Ikarashi, Y., <i>et al.</i> , <i>J. Chromatog.</i> , <b>322</b> , 191 (1985).
Trimethyllysine separation from trimethylornithine	AG 1-X8 resin; AG 50W-X8 resin	Lehman, L. J., <i>et al.</i> , <i>Anal. Biochem.</i> , <b>162</b> , 137 (1987).
Tryptamine concentration	Bio-Rex 70 resin	Larson, A. A. and Dalo, N. L., <i>J. Chromatog.</i> , <b>375</b> , 37 (1986).
Urine sample preparation	Bio-Rex 70 resin	Chan, Y. P. and Siu, T. S. S., <i>J. Chromatog.</i> , <b>459</b> , 251 (1988).





<b>Application</b>	<b>Product</b>	<b>Reference</b>
Urogastrone purification	Bio-Rex 70 resin	Savage, C. R. and Harper, R., <i>Anal. Biochem.</i> , <b>111</b> , 195 (1981).
Uronic and biouronic acids	AG 1-X8 resin	Johnson, S. and Samuelson, O., <i>Anal. Chim. Acta.</i> , <b>36</b> , 1 (1966).
Vitamin B <sub>6</sub> concentration	AG 50W-X8 resin	Tryfiates, G. P. and Sattangi, S., <i>J. Chromatog.</i> , <b>227</b> , 181 (1982).
Weak acid separation	AG 3-X4 resin	Dale, R. A., <i>Clin. Chim. Acta.</i> , <b>41</b> , 141 (1972).



# Organic Compound Removal and Concentration

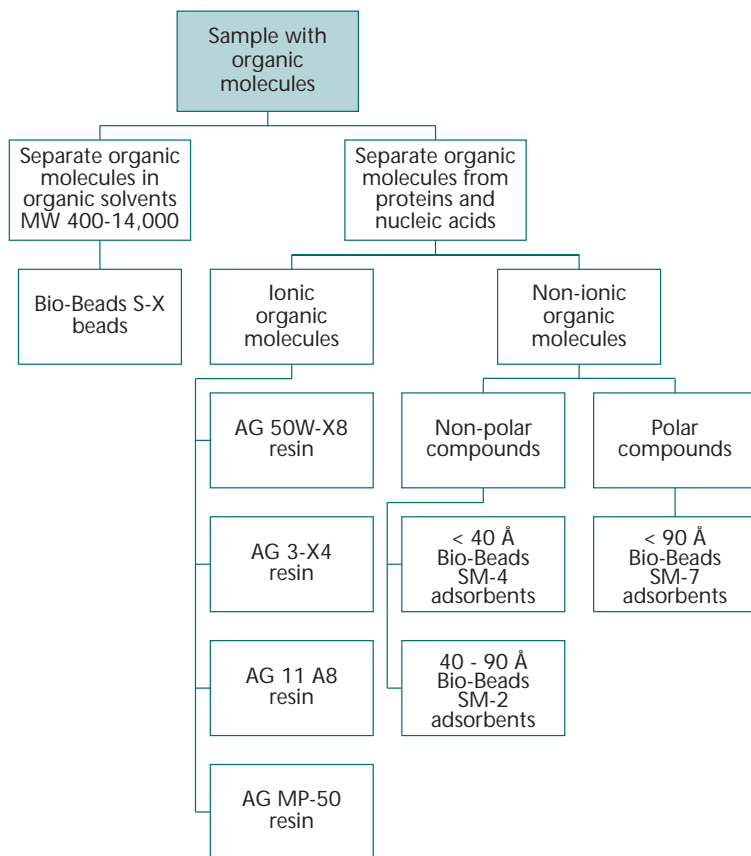

Table 6.1. Guide to Organic Compound Removal and Concentration

## Introduction

Several methods exist for removing or concentrating organic compounds. Either the organic compound can be bound and the other compounds of interest can be eluted, or the compounds of interest can be bound and the organic compound can be eluted. In many cases, as in many environmental applications, the organic compound is the compound of interest.



## Mechanisms

### Hydrophobic Interaction

Bio-Beads SM adsorbents use hydrophobic interaction chromatography to separate molecules. The adsorbents are neutral, macroporous polymeric beads with high surface areas for adsorbing organic molecules from aqueous solutions. Bio-Beads SM-2 and SM-4 adsorbents are used for the adsorption of nonpolar substances. Alternatively, Bio-Beads SM-7 adsorbents can be used for adsorbing polar substances from nonpolar solvents or for adsorbing nonpolar substances from polar solvents. Bio-Beads SM adsorbents have been used to remove detergents, emulsifiers, and wetting agents, as well as to separate water soluble steroids, phenols, drugs, and pesticides.

### Gel Permeation

Bio-Beads S-X beads are ideal for gel permeation separations of lipophilic polymers and other solutes using organic eluants. The beads have exclusion limits from 400 to 14,000 daltons and are particularly useful for separating low molecular weight organic polymers and other hydrophobic substances. Many different compounds have been separated on Bio-Beads S-X beads, including pesticides, rodenticides, polycyclic aromatic compounds, lipids, alkalines, fatty acids, polystyrenes, and a variety of hydrocarbons.

### Ion Exchange

Several ion exchange resins can be used to concentrate or separate ionic organic molecules. For example, AG 11 A8 ion retardation resin has the ability to adsorb mineral acids while allowing salts and organic molecules to pass through the column. The strong acid adsorption properties of AG 11 A8 resin make it ideal for the removal of hydrochloric acid from protein hydrolysates.

## Applications

### Biological Applications

Bio-Beads SM adsorbents are useful for removing polar and nonpolar compounds from solutions of proteins and nucleic acids, since the macroporous matrix of the adsorbent does not interact with the large biomolecules. Two common biological



applications are detergent removal with Bio-Beads SM-2 beads and ethidium bromide removal from nucleic acid preparations with Bio-Beads SM beads.

Additionally, Bio-Beads SM-2 beads can be used to remove excess rhodamine and fluorescein from their respective conjugated antibody solutions.

## Environmental Applications

### ***Pesticides, PCB, and PAH***

Bio-Beads S-X2 beads are very effective for cleanup of pesticides and polychlorinated biphenyl (PCB) residues in fish extracts.<sup>1</sup> Bio-Beads S-X3 beads have been used for specific separation of chlorinated pesticides from animal fat.<sup>2</sup> Clean-up of organochlorine compounds in dairy products was achieved using Bio-Beads S-X3 resin with a cyclohexane-ethanolacetate (EtOAc) eluant.<sup>3</sup> Recoveries were approximately 99% for most of the compounds studied. A rapid, easily automated method for the detection of polycyclic aromatic hydrocarbons (PAHs) in shellfish such as American lobster and blue mussel uses the gel permeation chromatography technique on Bio-Beads S-X beads.<sup>4</sup> The Bio-Beads procedure is ideal as a screening method in the range of 25–18,000 ng PAH per gram of tissue.

## References

<b>Application</b>	<b>Product</b>	<b>Reference</b>
Actinides extraction	Bio-Beads SM-2 beads	Green, L. W., <i>et al.</i> , <i>Anal. Chem.</i> , <b>55</b> , 2394 (1983).
Aflatoxin clean-up	Bio-Beads S-X3 beads	Hetmanski, M. T. and Scudamore, K. A., <i>Food Addit. Contam.</i> , <b>6</b> , 35 (1989).
Aminobenzylphosphonic acid purification	Bio-Beads SM-2 beads	Landt, M., <i>et al.</i> , <i>Biochem.</i> , <b>17</b> , 915 (1978).
Anabolic steroids in tissue	Bio-Beads SM-2 beads	Verbeke, R., <i>J. Chromatog.</i> , <b>177</b> , 69 (1979).
Bile acid adsorption	Bio-Beads SM-2 beads	Okuyama, S., <i>et al.</i> , <i>Bull. Chem. Soc. Japan</i> , <b>52</b> , 124 (1979); Schwarz, H. P., <i>et al.</i> , <i>Clin. Chim. Acta</i> , <b>50</b> , 197 (1974).
Chloramphenicol concentration	AG 50W-X8 resin	Schwartz, D. P. and McDonough, F. E., <i>JAOAC</i> , <b>67</b> , 563 (1984).
Chlorinated hydrocarbons in water	Bio-Beads SM-2 and SM-4 beads	Picer, N. and Picer, M., <i>J. Chromatog.</i> , <b>193</b> , 357 (1980).
Chlorinated pesticide adsorption	Bio-Beads SM-2 beads	McNeil, E. E. and Otsen, R., <i>J. Chromatog.</i> , <b>132</b> , 277 (1977).



Application	Product	Reference
Chlorophenol adsorption	Bio-Beads SM-2 beads	Grieser, M. D. and Pietrzyk, D. J., <i>Anal. Chem.</i> , <b>45</b> , 1348 (1973).
Cigarette smoke oxygenated component analysis	Bio-Beads S-X12 beads	Chamberlain, W. J., <i>et al.</i> , <i>Anal. Chim. Acta</i> , <b>111</b> , 235 (1979); Snook, M. E., <i>et al.</i> , <i>Anal. Chem.</i> , <b>47</b> , 1155 (1975).
Cobalamin adsorption	Bio-Beads SM-2 beads	Fenton, W. A. and Rosenberg, L. E., <i>Anal. Biochem.</i> , <b>90</b> , 119 (1978).
Environmental contaminant analysis	Bio-Beads S-X3 beads	Stalling, D. L., <i>et al.</i> , <i>ASTM Special Publication</i> <b>686</b> , 302 (1979).
Fish lipid extract analysis	Bio-Beads S-X3 beads	Burns, B. G., <i>et al.</i> , <i>JAOAC</i> , <b>64</b> , 282 (1981).
Food grade poly (vinyl chloride) resin fractionation	Bio-Beads S-X3 beads	Gilbert, J., <i>et al.</i> , <i>J. Chromatog.</i> , <b>320</b> , 361 (1985); Waliszewski, S. M. and Szymczynski, G. A., <i>J. Chromatog.</i> , <b>321</b> , 480 (1985).
Free rhodamine adsorption	Bio-Beads SM-2 beads	Spack, E. G., <i>et al.</i> , <i>Anal. Biochem.</i> <b>158</b> , 233 (1986).
Glucuronide adsorption	Bio-Beads SM-2 beads	Delaborde, S., <i>et al.</i> , <i>JHRC and CC</i> , <b>10</b> , 71 (1987).
Glucuronide adsorption from water	Bio-Beads SM-4 beads	White, J. D. and Schwartz, D. P., <i>J. Chromatog.</i> , <b>196</b> , 303 (1980).
Halogenated contaminant determination in tissue	Bio-Beads S-X3 beads	LeBel, G. L. and Williams, D. T., <i>JAOAC</i> , <b>69</b> , 1095 (1985).
Herbicide adsorption from soil	Bio-Beads SM-4 beads	Young, C. C., <i>Proc. Natl. Sci. Council., ROC (B)</i> , <b>8</b> , 119 (1984).
Humic complex concentration	Bio-Beads SM-2 beads	Hiraide, M., <i>et al.</i> , <i>Anal. Chim. Acta.</i> , <b>200</b> , 171 (1987).
Hydrocarbon adsorption from seawater	Bio-Beads SM-2 beads	Gomez-Bellinchon, J. I., <i>et al.</i> , <i>Environ. Sci. Technol.</i> , <b>22</b> , 667 (1988).
Leukotriene adsorption	Bio-Beads SM-2, SM-4, SM-7	Salari, H. and Steffenrud, S., <i>J. Chromatog.</i> , <b>378</b> , 35 (1986).
Mycotoxin adsorption from cereal	Bio-Beads SM-4 beads	Kamimura, H., <i>et al.</i> , <i>JAOAC</i> , <b>64</b> , 1067 (1981).
Nitrophenols adsorption	Bio-Beads SM-2 beads	Grieser, M. D. and Pietrzyk, D. J., <i>Anal. Chem.</i> , <b>45</b> , 1348 (1973).
Organochlorine concentration	Bio-Beads S-X3 beads	Venant, A., <i>et al.</i> , <i>Analysis</i> , <b>12</b> , 266 (1984).
Organophosphate residue analysis in crops	Bio-Beads S-X3 beads	Ault, J. A., <i>et al.</i> , <i>J. Ag. and Food Chem.</i> , <b>27</b> , 825 (1979).



Application	Product	Reference
Organophosphorous pesticide determination in food	Bio-Beads S-X3 beads	Blaha, J. J. and Jackson, P. J., <i>JAOAC</i> , <b>68</b> , 1095 (1985).
PAH determination in shellfish	Bio-Beads S-X3 beads	Musial, C. and Uthe, J. F., <i>JAOAC</i> , <b>69</b> , 462 (1986).
PCBs adsorption from seawater	Bio-Beads SM-2 beads	Gomez-Bellinchon, J. I., <i>et al.</i> , <i>Environ. Sci. Technol.</i> , <b>22</b> , 667 (1988).
Pesticide residue analysis	Bio-Beads S-X3 beads	Johnson, L. D., <i>et al.</i> , <i>JAOAC</i> , <b>59</b> , 174 (1976); Steinwandter, H., <i>Fresenius Z. Anal. Chem.</i> , <b>313</b> , 536 (1982).
Phenol adsorption	Bio-Beads SM-7 beads	Fritz, J. S. and Willis, R. B., <i>J. Chromatog.</i> , <b>79</b> , 107 (1973).
Phenolic acid adsorption from soil	Bio-Beads SM-4 beads	Young, C. C., <i>Proc. Natl. Sci. Council., ROC (B)</i> , <b>8</b> , 26 (1984); Young, C. C., <i>Soil Biol. Biochem.</i> , <b>16</b> , 377 (1984).
Phosphatidylcholine and adsorption	Bio-Beads SM-7 beads	Salari, H., <i>J. Chromatog.</i> , <b>419</b> , 103 (1987).
Phosphatidylethanolamine adsorption	Bio-Beads SM-2 beads	Salari, H., <i>J. Chromatog.</i> , <b>419</b> , 103 (1987).
Plant growth hormone adsorption	Bio-Beads SM-7 beads	Andersson, B. and Andersson, K., <i>J. Chromatog. Sci.</i> , <b>242</b> , 353 (1982).
Plant hormone adsorption	Bio-Beads SM-2 beads	Stafford, A. L., <i>et al.</i> , <i>J. Chromatog.</i> , <b>294</b> , 485 (1984).
Plasma clean-up	Bio-Beads SM-2 beads	Tamura, M., <i>et al.</i> , <i>Biochem.</i> , <b>26</b> , 2797 (1987).
Porphyrin purification	Bio-Beads S-X4 beads	Friley, B. K., <i>et al.</i> , <i>J. Chromatog.</i> , <b>258</b> , 310 (1983).
Proline isolation from fossil bone	Bio-Beads SM-2 beads	Stafford, T. W., <i>et al.</i> , <i>Life Sciences</i> , <b>31</b> , 931 (1982).
Prostaglandin adsorption from biological fluids	Bio-Beads SM-2 beads	Leffler, C. W., <i>et al.</i> , <i>Prostaglandins</i> , <b>21</b> , 227 (1981).
Pulmonary reaction to IV injected polymer beads	Bio-Beads S-X8 beads	Schoen, F., <i>et al.</i> , <i>J. Biomed. Materials Res.</i> , <b>20</b> , 709 (1986).
Purine, pyrimidine, and nucleoside adsorption	Bio-Beads SM-4 beads	Mills, G. C., <i>J. Chromatog.</i> , <b>242</b> , 103 (1982).
Rodenticide analysis in animal tissue	Bio-Beads S-X3 beads	Hunter, K., <i>J. Chromatog.</i> , <b>299</b> , 405 (1984); Hunter, K., <i>J. Chromatog.</i> , <b>321</b> , 255 (1985).
Sludge clean-up	Bio-Beads S-X3 beads	Haile, C. L. and Lopez-Avila, V., <i>USEPA Project Summary 600/S4-84-001</i> , March, 1984.
Steroid adsorption	Bio-Beads SM-4 beads	Shimada, K., <i>et al.</i> , <i>J. Chromatog.</i> , <b>378</b> , 17 (1986).
Steroid binding measurements	Hydroxylapatite	Nemoto, T., <i>et al.</i> , <i>Biochem.</i> , <b>29</b> , 1880 (1990).



<b>Application</b>	<b>Product</b>	<b>Reference</b>
Sulfathiazole concentration	AG MP-1 resin	Schwartz, D. P. and Sherma, J., <i>JAOAC</i> , <b>69</b> , 72 (1986).
Triadimefon adsorption from grapes	Bio-Beads SM-2 beads	Nickless, G. and Spitzer, T., <i>J. Chromatog.</i> , <b>208</b> , 409 (1981).

1. Stalling, *et al.*, *JAOAC*, **55**, 32 (1972).
2. Ault and Spurgeon, *JAOAC*, **76**, 2 (1984).
3. Venant, A., *et al.*, *Analysis*, **12**, 266 (1984).
4. Musial, C. J. and Uthe, J. F., *JAOAC*, **69**, 462 (1986).



# Columns and Accessories

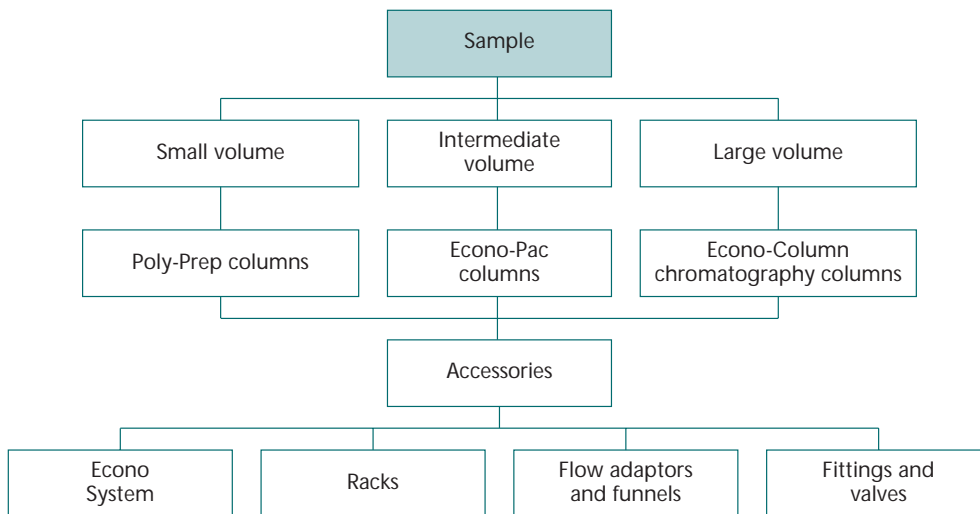

Table 7.1. Accessories for Sample Preparation

## Introduction

Bio-Rad offers a complete line of low pressure polypropylene and borosilicate glass chromatography columns, plus a wide selection of column accessories. Accessories include flow adaptors, reservoirs, funnels, valves, fittings, tubing, and racks; all essential components of high performance, low pressure chromatography.

## Columns

### Small Volume

#### ***Bio-Spin columns***

Bio-Spin columns are disposable, polypropylene columns for centrifuge and gravity flow chromatography applications. The Bio-Spin columns hold up to 1.2 ml of chromatography media and can be used with most 1.5 ml microtubes or 12 x 75 mm test tubes in centrifuge column applications. The columns have bed supports and are completely autoclavable.





***Poly-Prep  
columns***

Poly-Prep chromatography columns provide a number of conveniences for sample preparation and other small scale chromatography applications. The graduated 0.8 x 4 cm columns, constructed of high density polypropylene, hold a standard bed volume of 2 ml of chromatographic media and include a 10 ml reservoir. At the bottom of the column is a snap-off seal which leaves a male luer tip when removed. Poly-Prep columns are ideal for routine applications in which a small amount of chromatographic medium is used and then discarded, or for multiple sample clean-up applications.



*Chromatography columns.*

## Intermediate Volume

***Econo-Pac  
column***

Econo-Pac chromatography columns offer all the features of Poly-Prep columns with a 20 ml bed volume and a 10 ml reservoir to accommodate larger samples. In addition, the columns include an upper frit which protects the gel bed from disruption and prevents the column packing from drying.

## Large Volume

### *Econo-Column* *columns*

Econo-Column chromatography columns are borosilicate glass columns for low pressure (< 15 psi) chromatography applications in aqueous solutions. The columns have translucent end fittings for visualization of the entire the gel bed. The column tips have male Luer lock end fittings for easy connection to low pressure systems. Flow adaptors are available for the 1.0, 1.5, 2.5, and 5.0 cm ID columns.

## Systems and Accessories



*Automated Econo System.*

## Econo System

The Econo System brings a higher level of convenience, quality, and performance to low pressure chromatography than is possible using an assemblage of equipment. Designed for the purification of milligram quantities of proteins and nucleic acids, the Econo System is a series of high quality instruments and prepacked cartridges that combine to create an integrated low pressure chromatography system which delivers outstanding performance at an economical price. The system can be completely automated, from sample injection to fraction collection, allowing for walk-away operation.

## Flow Adaptors

Flow adaptors improve column performance by reducing sample dilution and by protecting the gel bed. Econo-Column flow adaptors have a three position cam and a Derlin housing that snaps on to the column. They are available for 1.0, 1.5, 2.5, and 5.0\* cm Econo-Column chromatography columns and are compatible with jacketed Econo-Column chromatography columns as well as Econo-Pac columns.

## Tubing and Fittings

Bio-Rad carries a complete line of fittings, tubing, and valves for plumbing low pressure chromatography set-ups. Fittings are constructed of polypropylene and exhibit excellent chemical compatibility. Luer fittings can be quickly and easily fitted to most flexible tubing. Small, medium, and large barbs are available for 0.8 mm, 1.6 mm, and 3.2 mm ID tubing. Bio-Rad supplies silicone, Tygon, and PharMed tubing for any low pressure application.

## Poly Column Rack

The Poly Column Rack provides convenience in using Poly-Prep and Econo-Pac columns. The rack holds up to 20 Poly-Prep columns or 10 Econo-Pac columns, and includes a collection trough for large volumes of effluent.

\*5.0 cm flow adaptor lacks cam mechanism.



# Product Information

## Membrane Filters for Particulate Removal

Catalog Number	Product Description
----------------	---------------------

### Prep-Disc Membrane Filters

343-0002	0.2 µm Prep-Disc Membrane Filter, 50
343-0001	0.45 µm Prep-Disc Membrane Filter, 50
343-0004	1.0 µm Prep-Disc Membrane Filter, 50
343-0005	5.0 µm Prep-Disc Membrane Filter, 50

### Micro Prep-Disc Membrane Filters

343-0011	0.2 µm Micro Prep-Disc Membrane Filter, 50
343-0012	0.45 µm Micro Prep-Disc Membrane Filter, 50
343-0014	1.0 µm Micro Prep-Disc Membrane Filter, 50
343-0015	5.0 µm Micro Prep-Disc Membrane Filter, 50

## Ion Exchange Chromatography Resins

Catalog Number	Product Description	Ionic Form	Mesh Size	Package Size
----------------	---------------------	------------	-----------	--------------

### Analytical Grade Resins

140-1231	AG 1-X2 Resin	Chloride	50–100	500 g
140-1241	AG 1-X2 Resin	Chloride	100–200	500 g
140-1251	AG 1-X2 Resin	Chloride	200–400	500 g
140-1253	AG 1-X2 Resin	Acetate	200–400	500 g
140-1331	AG 1-X4 Resin	Chloride	50–100	500 g
140-1341	AG 1-X4 Resin	Chloride	100–200	500 g
140-1351	AG 1-X4 Resin	Chloride	200–400	500 g
140-1421	AG 1-X8 Resin	Chloride	20–50	500 g
140-1422	AG 1-X8 Resin	Hydroxide	20–50	500 g
140-1431	AG 1-X8 Resin	Chloride	50–100	500 g
140-1441	AG 1-X8 Resin	Chloride	100–200	500 g
140-1443	AG 1-X8 Resin	Acetate	100–200	500 g
140-1444	AG 1-X8 Resin	Formate	100–200	500 g
140-1451	AG 1-X8 Resin	Chloride	200–400	500 g
140-1453	AG 1-X8 Resin	Acetate	200–400	500 g
140-1454	AG 1-X8 Resin	Formate	200–400	500 g
140-2421	AG 2-X8 Resin	Chloride	20–50	500 g
140-2441	AG 2-X8 Resin	Chloride	100–200	500 g
140-2451	AG 2-X8 Resin	Chloride	200–400	500 g
141-0831	AG MP-1 Resin	Chloride	50–100	500 g

### Ion Exchange Chromatography Resins (continued)

Catalog Number	Product Description	Ionic Form	Mesh Size	Package Size
<b>Analytical Grade Resins (continued)</b>				
141-0841	AG MP-1 Resin	Chloride	100–200	500 g
141-0851	AG MP-1 Resin	Chloride	200–400	500 g
140-4341	AG 4-X4 Resin	Free Base	100–200	500 g
140-5341	AG 3-X4 Resin	Free Base	100–200	500 g
142-1231	AG 50W-X2 Resin	Hydrogen	50–100	500 g
142-1241	AG 50W-X2 Resin	Hydrogen	100–200	500 g
142-1251	AG 50W-X2 Resin	Hydrogen	200–400	500 g
142-1331	AG 50W-X4 Resin	Hydrogen	50–100	500 g
142-1341	AG 50W-X4 Resin	Hydrogen	100–200	500 g
142-1351	AG 50W-X4 Resin	Hydrogen	200–400	500 g
142-1421	AG 50W-X8 Resin	Hydrogen	20–50	500 g
142-1431	AG 50W-X8 Resin	Hydrogen	50–100	500 g
142-1441	AG 50W-X8 Resin	Hydrogen	100–200	500 g
142-1451	AG 50W-X8 Resin	Hydrogen	200–400	500 g
142-1641	AG 50W-X12 Resin	Hydrogen	100–200	500 g
142-1651	AG 50W-X12 Resin	Hydrogen	200–400	500 g
143-0841	AG MP-50 Resin	Hydrogen	100–200	500 g
142-6424	AG 501-X8 Resin	H <sup>+</sup> & OH <sup>-</sup>	20–50	500 g
142-6425	AG 501-X8(D) Resin	H <sup>+</sup> & OH <sup>-</sup>	20–50	500 g
142-7425	Bio-Rex MSZ 501(D)	H <sup>+</sup> & OH <sup>-</sup>	25–35	500 g
142-7834	AG 11 A8 Resin	Self adsorbed	50–100	500 g
142-2822	Chelex 100 Resin	Sodium	50–100	500 g
142-2832	Chelex 100 Resin	Sodium	100–200	500 g
142-2842	Chelex 100 Resin	Sodium	200–400	500 g
142-2825	Chelex 100 Resin	Iron	100–200	100 g
745-7000	Chelex 20 Resin	Sodium	20–50	500 g
745-7001	Chelex 20 Resin	Sodium	20–50	10 kg
140-7841	Bio-Rex 5 Resin	Chloride	100–200	500 g
140-7851	Bio-Rex 5 Resin	Chloride	200–400	500 g
142-5822	Bio-Rex 70 Resin	Sodium	20–50	500 g
142-5832	Bio-Rex 70 Resin	Sodium	50–100	500 g
142-5842	Bio-Rex 70 Resin	Sodium	100–200	500 g
142-5852	Bio-Rex 70 Resin	Sodium	200–400	500 g
<b>Prefilled Poly-Prep Columns</b>				
731-6211	AG 1-X8 Resin, 2 ml	Chloride	100–200	50
731-6212	AG 1-X8 Resin, 2 ml	Chloride	200–400	50
731-6221	AG 1-X8 Resin, 2 ml	Formate	200–400	50
731-6213	AG 50W-X8 Resin, 2 ml	Hydrogen	100–200	50
731-6214	AG 50W-X8 Resin, 2 ml	Hydrogen	200–400	50

**Ion Exchange Chromatography Resins (continued)**

Catalog Number	Product Description	Ionic Form	Mesh Size	Package Size
<b>Biotechnology Grade Resins</b>				
143-1255	AG 1-X2 Resin	Hydroxide	200–400	100 g
143-1345	AG 1-X4 Resin	Hydroxide	100–200	100 g
143-2445	AG 1-X8 Resin	Hydroxide	100–200	100 g
143-2446	AG 1-X8 Resin	Hydroxide	200–400	100 g
143-3341	AG 4-X4 Resin	Free Base	100–200	100 g
143-5241	AG 50W-X2 Resin	Hydrogen	100–200	100 g
143-5341	AG 50W-X4 Resin	Hydrogen	200–400	100 g
143-5441	AG 50W-X8 Resin	Hydrogen	100–200	100 g
143-5451	AG 50W-X8 Resin	Hydrogen	200–400	100 g
143-7424	AG 501-X8 Resin	H <sup>+</sup> & OH <sup>-</sup>	20–50	100 g
143-7425	AG 501-X8(D) Resin	H <sup>+</sup> & OH <sup>-</sup>	20–50	100 g
143-7834	AG 11 A8 Resin	Self adsorbed	50–100	100 g
143-5832	Bio-Rex 70 Resin	Sodium	50–100	100 g
143-5852	Bio-Rex 70 Resin	Sodium	200–400	100 g
143-2832	Chelex 100 Resin	Sodium	100–200	100 g
<b>Molecular Biology Grade Resins</b>				
143-1441	AG 50W-X8 Resin	Sodium	100–200	100 g
143-1451	AG 50W-X8 Resin	Sodium	200–400	100 g
143-6424	AG 501-X8 Resin	H <sup>+</sup> & OH <sup>-</sup>	20–50	100 g
143-6425	AG 501-X8(D) Resin	H <sup>+</sup> & OH <sup>-</sup>	20–50	100 g
<b>Macro-Prep Ion Exchange Supports</b>				
156-0040	Macro-Prep High Q Support			100 ml
156-0041	Macro-Prep High Q Support			500 ml
156-0042	Macro-Prep High Q Support			5 liters
156-0043	Macro-Prep High Q Support			10 liters
156-0050	Macro-Prep Q Support			100 ml
156-0051	Macro-Prep Q Support			500 ml
156-0052	Macro-Prep Q Support			5 liters
156-0053	Macro-Prep Q Support			10 liters
156-0030	Macro-Prep High S Support			100 ml
156-0031	Macro-Prep High S Support			500 ml
156-0032	Macro-Prep High S Support			5 liters
156-0033	Macro-Prep High S Support			10 liters
156-0060	Macro-Prep S Support			100 ml
156-0061	Macro-Prep S Support			500 ml
156-0062	Macro-Prep S Support			5 liters
156-0063	Macro-Prep S Support			10 liters
156-0020	Macro-Prep DEAE Support			100 ml
156-0021	Macro-Prep DEAE Support			500 ml

### Ion Exchange Chromatography Resins (continued)

Catalog Number	Product Description	Package Size
<b>Macro-Prep Ion Exchange Supports (continued)</b>		
156-0022	Macro-Prep DEAE Support	5 liters
156-0023	Macro-Prep DEAE Support	10 liters
156-0070	Macro-Prep CM Support	100 ml
156-0071	Macro-Prep CM Support	500 ml
156-0072	Macro-Prep CM Support	5 liters
156-0073	Macro-Prep CM Support	10 liters

### Econo-Pac Cartridges

731-0026	Econo-Pac High Q Cartridge, 5 ml	1
731-0027	Econo-Pac High Q Cartridge, 5 ml	5
731-0028	Econo-Pac High Q Cartridge, 1 ml	5
732-0021	Econo-Pac Q Cartridge, 5 ml	1
732-0025	Econo-Pac Q Cartridge, 5 ml	5
732-0023	Econo-Pac Q Cartridge, 1 ml	5
731-0066	Econo-Pac High S Cartridge, 5 ml	1
731-0067	Econo-Pac High S Cartridge, 5 ml	5
731-0068	Econo-Pac High S Cartridge, 1 ml	5
732-0061	Econo-Pac S Cartridge, 5 ml	1
732-0065	Econo-Pac S Cartridge, 5 ml	5
732-0063	Econo-Pac S Cartridge, 1 ml	5
732-0001	Econo-Pac CM Cartridge, 5 ml	1
732-0005	Econo-Pac CM Cartridge, 5 ml	5
732-0003	Econo-Pac CM Cartridge, 1 ml	5

### Bio-Gel A Ion Exchangers

153-0740	DEAE Bio-Gel A Agarose	250 ml
153-0840	CM Bio-Gel A Agarose	250 ml

### Hydrophobic Interaction Chromatography Supports

Catalog Number	Product Description	Package Size
<b>Macro-Prep Supports</b>		
156-0080	Macro-Prep Methyl HIC Support	100 ml
156-0081	Macro-Prep Methyl HIC Support	500 ml
156-0082	Macro-Prep Methyl HIC Support	5 liters
156-0083	Macro-Prep Methyl HIC Support	10 liters
156-0090	Macro-Prep t-Butyl HIC Support	100 ml
156-0091	Macro-Prep t-Butyl HIC Support	500 ml
156-0092	Macro-Prep t-Butyl HIC Support	5 liters
156-0093	Macro-Prep t-Butyl HIC Support	10 liters

### Hydrophobic Interaction Chromatography Resins (continued)

Catalog Number	Product Description	Wet Particle Size (µm)	Package Size
<b>Econo-Pac Cartridges</b>			
732-0051	Econo-Pac Methyl HIC Cartridge, 5 ml		1
732-0055	Econo-Pac Methyl HIC Cartridge, 5 ml		5
732-0053	Econo-Pac Methyl HIC Cartridge, 1 ml		5
731-0056	Econo-Pac t-Butyl Cartridge, 5 ml		1
731-0057	Econo-Pac t-Butyl Cartridge, 5 ml		5
731-0058	Econo-Pac t-Butyl Cartridge, 1 ml		5

### Bio-Beads SM Adsorbents

152-3920	Bio-Beads SM-2 Beads	300–1,180	100 g
152-8920	Bio-Beads SM-2 Beads, biotechnology grade	300–1,180	25 g
152-3924	Bio-Beads SM-2 Beads	63–150	25 g
152-3934	Bio-Beads SM-2 Beads	63–150	100 g
152-4020	Bio-Beads SM-4 Beads	300–1,180	100 g
152-4320	Bio-Beads SM-7 Beads	300–1,180	100 g
152-4334	Bio-Beads SM-7 Beads	63–150	100 g

### Gel Filtration Chromatography Supports

Catalog Number	Product Description	Wet Particle Size (µm)	Package Size
<b>Bio-Gel P Polyacrylamide Gels</b>			
150-4114	Bio-Gel P-2 Gel, fine	45–90	100 g
150-4115	Bio-Gel P-2 Gel, fine	45–90	500 g
150-4118	Bio-Gel P-2 Gel, extra fine	<45	100 g
150-4120	Bio-Gel P-4 Gel, medium	90–180	100 g
150-4124	Bio-Gel P-4 Gel, fine	45–90	100 g
150-4128	Bio-Gel P-4 Gel, extra fine	<45	100 g
150-4130	Bio-Gel P-6 Gel, medium	90–180	100 g
150-4134	Bio-Gel P-6 Gel, fine	45–90	100 g
150-4138	Bio-Gel P-6 Gel, extra fine	<45	100 g
150-0738	Bio-Gel P-6DG Gel, medium	90–180	100 g
150-0739	Bio-Gel P-6DG Gel, medium	90–180	1 kg
150-4140	Bio-Gel P-10 Gel, medium	90–180	100 g
150-4144	Bio-Gel P-10 Gel, fine	45–90	100 g
150-4150	Bio-Gel P-30 Gel, medium	90–180	100 g
150-4154	Bio-Gel P-30 Gel, fine	45–90	100 g
150-4160	Bio-Gel P-60 Gel, medium	90–180	100 g
150-4164	Bio-Gel P-60 Gel, fine	45–90	100 g
150-4170	Bio-Gel P-100 Gel, medium	90–180	100 g
150-4174	Bio-Gel P-100 Gel, fine	45–90	100 g



### Gel Filtration Chromatography Supports (continued)

Catalog Number	Product Description	Wet Particle Size ( $\mu\text{m}$ )	Package Size
<b>Econo-Pac Columns and Cartridges</b>			
732-0011	Econo-Pac P6 Cartridge, 5 ml	90-180	1
732-0015	Econo-Pac P6 Cartridge, 5 ml	90-180	5
732-6000	Bio-Spin 6 Chromatography Column	90-180	10
732-6002	Bio-Spin 6 Chromatography Column	90-180	25
732-6004	Bio-Spin 30 Chromatography Column	90-180	10
732-6006	Bio-Spin 30 Chromatography Column	90-180	25
732-2010	Econo-Pac 10DG Column, 10 ml	90-180	30

### Bio-Gel A Agarose Gels

151-0130	Bio-Gel A-0.5m Gel, coarse	150-300	500 ml
151-0140	Bio-Gel A-0.5m Gel, medium	75-150	500 ml
151-0150	Bio-Gel A-0.5m Gel, fine	38-75	500 ml
151-0430	Bio-Gel A-1.5m Gel, coarse	150-300	500 ml
151-0440	Bio-Gel A-1.5m Gel, medium	75-150	500 ml
151-0450	Bio-Gel A-1.5m Gel, fine	38-75	500 ml
151-0730	Bio-Gel A-5m Gel, coarse	150-300	500 ml
151-0740	Bio-Gel A-5m Gel, medium	75-150	500 ml
151-0750	Bio-Gel A-5m Gel, fine	38-75	500 ml
151-1030	Bio-Gel A-15m Gel, coarse	150-300	500 ml
151-1040	Bio-Gel A-15m Gel, medium	75-150	500 ml
151-1050	Bio-Gel A-15m Gel, fine	38-75	500 ml
151-1330	Bio-Gel A-50m Gel, coarse	150-300	500 ml
151-1340	Bio-Gel A-50m Gel, medium	75-150	500 ml
151-1901	Gel Filtration Standard, 18 mg		6 vials

### Bio-Beads S-X Beads

152-2150	Bio-Beads S-X1 Beads	40-80	100 g
152-2151	Bio-Beads S-X1 Beads	40-80	1 kg
152-2750	Bio-Beads S-X3 Beads	40-80	100 g
152-3350	Bio-Beads S-X8 Beads	40-80	100 g
152-3650	Bio-Beads S-X12 Beads	40-80	100 g

### Affinity Chromatography Supports

Catalog Number	Product Description	Package Size
<b>Ready-to-Use Affinity Supports</b>		
153-7301	Affi-Gel Blue Gel, 50-100 mesh	100 ml
153-7302	Affi-Gel Blue Gel, 100-200 mesh	100 ml
153-7307	DEAE Affi-Gel Blue Gel	100 ml
153-7304	CM Affi-Gel Blue Gel	100 ml

## Affinity Chromatography Supports (continued)

Catalog Number	Product Description	Package Size
<b>Ready-to-Use Affinity Supports (continued)</b>		
153-6153	Affi-Gel Protein A Agarose	5 ml
153-6154	Affi-Gel Protein A Agarose	50 ml
153-6159	Affi-Gel Protein A MAPS II Kit	
153-6160	Affi-Gel Protein A MAPS II Buffers	
153-6161	Protein A MAPS II Binding Buffer	5 liters
153-6162	Protein A MAPS II Elution Buffer	5 liters
153-6166	Affi-Gel Protein A MAPS II Regeneration Buffer	5 liters
156-0006	Affi-Prep Protein A Support	5 ml
156-0005	Affi-Prep Protein A Support	25 ml
153-6165	Affi-Prep Protein A MAPS II Kit	
153-6164	Affi-Prep Protein A MAPS II Buffers	
153-6173	Affi-Gel Heparin Gel	40 ml
156-0010	Affi-Prep Polymyxin Support	25 ml
153-5199	Affi-Gel 501 Gel	10 ml
153-6101	Affi-Gel 601 Gel	5 g
<b>Activated Affinity Supports</b>		
153-6099	Affi-Gel 10 Gel	25 ml
153-6046	Affi-Gel 10 Gel	4 x 25 ml
153-6051	Affi-Gel 15 Gel	25 ml
153-6052	Affi-Gel 15 Gel	4 x 25 ml
153-6098	Affi-Gel 10/15 Combination	2 x 25 ml of each
156-0002	Affi-Prep 10 Support	1 x 25 ml
156-0001	Affi-Prep 10 Support	4 x 25 ml
156-0003	Affi-Prep 10 Support	500 ml
156-0004	Affi-Prep 10 Support	1000 ml
153-6047	Affi-Gel Hz Hydrazide Gel	25 ml
153-6060	Affi-Gel Hz Immunoaffinity Kit	
153-6054	Affi-Gel Hz 10x Coupling Buffer Concentrate	500 ml
153-6055	Affi-Gel Oxidizer	250 mg
156-0015	Affi-Prep Hydrazide Support	5 ml
156-0016	Affi-Prep Hydrazide Support	25 ml
156-0017	Affi-Prep Hydrazide Support	500 ml
<b>Carbodiimide Activated Supports</b>		
153-2401	Affi-Gel 102 Gel	50 ml
153-0840	CM Bio-Gel A Gel	250 ml
153-0990	EDAC	5 g

### Affinity Chromatography Supports (continued)

Catalog Number	Product Description	Package Size
<b>Econo-Pac Columns and Cartridges</b>		
732-2026	Econo-Pac Serum IgG Purification Column, 10 ml	5
732-2027	Econo-Pac Serum IgG Purification Kit	
732-0101	Econo-Pac Blue Cartridge, 5 ml	1
732-0105	Econo-Pac Blue Cartridge, 5 ml	5
732-0031	Econo-Pac DEAE Blue Cartridge, 5 ml	1
732-0035	Econo-Pac DEAE Blue Cartridge, 5 ml	5
732-2022	Econo-Pac Protein A Column, 2 ml	5
732-2020	Econo-Pac Protein A Kit	
732-0091	Econo-Pac Protein A Cartridge, 5 ml	1
732-0093	Econo-Pac Protein A Cartridge, 1 ml	5
732-0071	Econo-Pac Heparin Cartridge, 5 ml	1
732-0075	Econo-Pac Heparin Cartridge, 5 ml	5

### Hydroxyapatite Chromatography Supports

Catalog Number	Product Description	Package Size
<b>Bio-Gel Hydroxyapatite Media</b>		
130-0150	Bio-Gel HT Hydroxyapatite	250 ml
130-0151	Bio-Gel HT Hydroxyapatite	500 ml
130-0420	Bio-Gel HTP Hydroxyapatite	100 g
130-0421	Bio-Gel HTP Hydroxyapatite	1 kg
130-0520	Bio-Gel HTP Hydroxyapatite, DNA grade	100 g
<b>Macro-Prep Hydroxyapatite Supports</b>		
157-0020	Macro-Prep Ceramic Hydroxyapatite, 20 $\mu$ m	100 g
157-0021	Macro-Prep Ceramic Hydroxyapatite, 20 $\mu$ m	1 kg
157-0025	Macro-Prep Ceramic Hydroxyapatite, 20 $\mu$ m	5 kg
157-0040	Macro-Prep Ceramic Hydroxyapatite, 40 $\mu$ m	100 g
157-0041	Macro-Prep Ceramic Hydroxyapatite, 40 $\mu$ m	1 kg
157-0045	Macro-Prep Ceramic Hydroxyapatite, 40 $\mu$ m	5 kg
157-0080	Macro-Prep Ceramic Hydroxyapatite, 80 $\mu$ m	100 g
157-0081	Macro-Prep Ceramic Hydroxyapatite, 80 $\mu$ m	1 kg
157-0085	Macro-Prep Ceramic Hydroxyapatite, 80 $\mu$ m	5 kg

### Econo-Pac Cartridges

732-0081	* Econo-Pac HTP Cartridge, 5 ml	1
732-0085	* Econo-Pac HTP Cartridge, 5 ml	5
732-0083	* Econo-Pac HTP Cartridge, 1 ml	5

\* Contains Macro-Prep ceramic hydroxyapatite, Type 2

## DNA Purification Supports

Catalog Number	Product Description	Package Size
<b>Prep-A-Gene DNA Purification Reagents</b>		
732-6012	Prep-A-Gene DNA Purification Matrix	2 ml
732-6013	Prep-A-Gene DNA Purification Matrix	12 ml
732-6010	Prep-A-Gene DNA Purification Kit	2 ml
732-6011	Prep-A-Gene DNA Purification Kit	12 ml
732-6017	Prep-A-Gene Plasmid Purification Kit	2 ml
732-6019	Prep-A-Gene Plasmid Purification Kit	12 ml
732-6021	Prep-A-Gene Plasmid Buffer Kit	
732-6022	Prep-A-Gene Binding Buffer	500 ml
732-6023	Prep-A-Gene Plasmid Binding Buffer	500 ml
732-6024	Prep-A-Gene Wash Buffer	250 ml
732-6026	Prep-A-Gene Elution Buffer	125 ml
<b>InstaGene DNA Purification Matrix</b>		
732-6030	InstaGene DNA Purification Matrix	20 ml

## Chromatography Columns

Catalog Number	ID (cm)	Length (cm)	Area (cm <sup>2</sup> )	Max Vol (ml)	Package Size
<b>Standard Econo-Column Columns</b>					
737-0506	0.5	5	0.20	1	5
737-0507	0.5	5	0.20	1	2
737-0511	0.5	10	0.20	2	5
737-0512	0.5	10	0.20	2	2
737-0516	0.5	15	0.20	3	5
737-0517	0.5	15	0.20	3	2
737-0521	0.5	20	0.20	4	5
737-0522	0.5	20	0.20	4	2
737-0706	0.7	5	0.39	2	5
737-0707	0.7	5	0.39	2	2
737-0711	0.7	10	0.39	4	5
737-0712	0.7	10	0.39	4	2
737-0716	0.7	15	0.39	6	5
737-0717	0.7	15	0.39	6	2
737-0721	0.7	20	0.39	8	5
737-0722	0.7	20	0.39	8	2
737-0731	0.7	30	0.39	12	5
737-0732	0.7	30	0.39	12	2
737-0751	0.7	50	0.39	20	5
737-0752	0.7	50	0.39	20	2
737-1006	1.0	5	0.79	4	5

**Chromatography Columns (continued)**

Catalog Number	ID (cm)	Length (cm)	Area (cm <sup>2</sup> )	Max Vol (ml)	Package Size
<b>Standard Econo-Column Columns (continued)</b>					
737-1007	1.0	5	0.79	4	2
737-1011	1.0	10	0.79	8	5
737-1012	1.0	10	0.79	8	2
737-1021	1.0	20	0.79	16	5
737-1022	1.0	20	0.79	16	2
737-1031	1.0	30	0.79	24	5
737-1032	1.0	30	0.79	24	2
737-1051	1.0	50	0.79	40	5
737-1052	1.0	50	0.79	40	2
737-1091	1.0	100	0.79	79	2
737-1093	1.0	120	0.79	103	2
737-1506	1.5	5	1.77	9	5
737-1507	1.5	5	1.77	9	2
737-1511	1.5	10	1.77	18	5
737-1512	1.5	10	1.77	18	2
737-1516	1.5	15	1.77	27	5
737-1517	1.5	15	1.77	27	2
737-1521	1.5	20	1.77	35	5
737-1522	1.5	20	1.77	35	2
737-1531	1.5	30	1.77	53	5
737-1532	1.5	30	1.77	53	2
737-1551	1.5	50	1.77	89	5
737-1552	1.5	50	1.77	89	2
737-1576	1.5	75	1.77	124	2
737-1591	1.5	100	1.77	177	2
737-1593	1.5	120	1.77	230	2
737-1598	1.5	170	1.77	301	2
737-2506	2.5	5	4.91	25	5
737-2507	2.5	5	4.91	25	2
737-2511	2.5	10	4.91	49	5
737-2512	2.5	10	4.91	49	2
737-2521	2.5	20	4.91	98	5
737-2522	2.5	20	4.91	98	2
737-2531	2.5	30	4.91	147	5
737-2532	2.5	30	4.91	147	2
737-2551	2.5	50	4.91	246	2
737-2576	2.5	75	4.91	344	2
737-2591	2.5	100	4.91	491	2
737-2593	2.5	120	4.91	638	2
737-5011	5.0	10	19.63	196	1

### Chromatography Columns (continued)

Catalog Number	ID (cm)	Length (cm)	Area (cm <sup>2</sup> )	Max Vol (ml)	Package Size
----------------	---------	-------------	-------------------------	--------------	--------------

#### Standard Econo-Column Columns (continued)

737-5021	5.0	20	19.63	393	1
737-5031	5.0	30	19.63	589	1
737-5051	5.0	50	19.63	982	1
737-5071	5.0	70	19.63	1374	1

#### Standard Jacketed Econo-Column Columns

737-6108	0.7	15	0.37	6	1
737-6116	1.0	15	0.79	12	1
737-6131	1.0	30	0.79	25	1
737-6151	1.5	50	1.77	89	1

#### Opened-Ended Jacketed Econo-Column Chromatography Columns, two flow adaptors included

737-6201	1.0	30	0.79	25	1
----------	-----	----	------	----	---

Catalog Number	Product Description	Column ID (cm)	Functional Length (cm)
----------------	---------------------	----------------	------------------------

#### Flow Adaptors

738-0014	Flow Adaptor	1.0	1 to 7
738-0015	Flow Adaptor	1.0	1 to 14
738-0016	Flow Adaptor	1.5	1 to 14
738-0017	Flow Adaptor	2.5	1 to 14
738-0018	Flow Adaptor	5.0	1 to 14
738-0019	Econo-Pac Flow Adaptor	1.5	1 to 7

#### Glass Reservoirs

737-9112	Econo-Column Reservoir, 500 ml
737-9113	Econo-Column Reservoir, 1,000 ml

#### Econo-Column Funnels

731-0003	Econo-Column Funnel, 250 ml, 5
----------	--------------------------------

#### Bio-Spin Columns

732-6008	Bio-Spin Chromatography Columns, empty, 100
----------	---

#### Poly-Prep Columns

731-1550	Poly-Prep Columns, empty, 50
731-1555	Poly-Prep Column Stack Cap, 50
731-7005	Poly Column Rack, 20 place, with removable tube rack
732-8102	2-way Stopcock, 10
731-8232	Female Luer Plug, 25

### Chromatography Columns (continued)

Catalog Number	ID (cm)	Length (cm)	Area (cm <sup>2</sup> )	Max Vol (ml)	Package Size
----------------	---------	-------------	-------------------------	--------------	--------------

#### Econo-Pac Columns

732-1010	Econo-Pac Columns, empty, 50				
738-0019	Econo-Pac Flow Adaptor, 1				
732-8102	2-way Stopcock, 10				

#### Econo Systems and Accessories

Catalog Number	Product Description
----------------	---------------------

#### Econo Systems

731-8101	Econo System, complete, includes pump, UV monitor, Model 2110 fraction collector, system controller, rack, and single-pen chart recorder (Model 1325)
731-8098	Econo System, complete. Same as 731-8101 except 220/240 V
731-8114	Automated Econo System, includes pump, UV monitor, Model 2128 fraction collector, system controller, rack, and dual-pen chart recorder (Model 1327), buffer selector, organizer, and gradient monitor.
731-8099	Automated Econo System, complete. Same as 731-8114 except 220/240 V

Catalog Number	Product Description	ID (mm)	Wall (mm)	Length (meters)
----------------	---------------------	---------	-----------	-----------------

#### Tubing

731-8210	Silicone Tubing	0.8	0.8	10
731-8211	Silicone Tubing	1.6	0.8	10
731-8212	Silicone Tubing	3.2	0.8	10
731-8214	Tygon Tubing	0.8	0.8	10
731-8215	Tygon Tubing	1.6	0.8	10
731-8207	PharMed Tubing	0.8	0.8	10
731-8208	PharMed Tubing	1.6	0.8	10
731-8209	PharMed Tubing	3.2	0.8	10
732-8204	Teflon Tubing	1.6	0.8	5
731-8240	Pump Tubing Kit, 20 precut tubes and 0.8 mm ID silicone, 4 sets of fittings			
731-8241	Pump Tubing Kit, 20 precut tubes and 1.6 mm ID silicone, 4 sets of fittings			
732-8242	Pump Tubing Kit, 20 precut tubes and 3.2 mm ID silicone, 4 sets of fittings			
731-8247	Pump Tubing Kit, 20 precut tubes and 0.8 mm ID PharMed, 4 sets of fittings			
731-8248	Pump Tubing Kit, 20 precut tubes and 1.6 mm ID PharMed, 4 sets of fittings			
731-8249	Pump Tubing Kit, 20 precut tubes and 3.2 mm ID PharMed, 4 sets of fittings			
731-8232	Female Luer Plug, 25			

#### Poly Column Rack

731-7005	Poly Column Rack, 20 place, with removable tube rack				
----------	--	--	--	--	--

# Literature Available

---

## Chromatographic Supports

---

Bulletin Number	Product Information
--------------------	---------------------

---

### General Chromatography Applications

1800	Nucleic Acid Analysis Applications
1801	Protein and Peptide Purification Applications
1802	Antibody Purification Applications
1803	Environmental Analysis Applications
1825	Guide to Sample Preparation, 1994

### Ion Exchange Chromatography

1075	DEAE and CM Bio-Gel A Ion Exchange Gels
1224	Chelex 20 Resin for Industrial Heavy Metal Removal
1441	Guide to Ion Exchange (see page 84)
1747	Econo-Pac HTP and Protein A Cartridges
1752	Process Scale Media Guide
1840 A-100	Macro-Prep Q Support
1840 A-200	Macro-Prep S Support
1840 A-300	Macro-Prep CM Support
1840 A-400	Macro-Prep DEAE Support

### Affinity Chromatography

1066	Affi-Gel 601 Affinity Chromatography Gel
1085	Affi-Gel 10 and 15 Activated Supports
1092	CM Affi-Gel Blue Gel for Protease Free Globulin Fraction From Serum
1099	Immunoaffinity Chromatography
1107	Affi-Gel Blue gel for Enzyme and Blood Protein Purification
1298	Affi-Prep 10 Medium and High Pressure Affinity Matrix
1424	Affi-Gel Hz Immunoaffinity Kit
1429	Affi-Prep Polymyxin Endotoxin Removal Gel

### Hydrophobic Interaction Chromatography

1461	Bio-Beads SM Adsorbent Applications Bibliography
1841 B-100	Macro-Prep HIC Support

### Hydroxyapatite Chromatography

1115	HPHT Hydroxyapatite Column
1842 C-100	Macro-Prep Ceramic Hydroxyapatite



## Chromatography Columns and Accessories

---

Bulletin Number	Product Information
--------------------	---------------------

---

### Empty Low Pressure Chromatography Columns

1728	Low Pressure Chromatography Columns and Accessories
------	---

### Prefilled Low Pressure Columns

1726	Bio-Spin 6 and 30 Spin Chromatography Columns
1789	Econo-Pac Cartridges
1826	Enzyme Purification with the Econo-Pac Q Cartridge
1827	Plasmid Purification with the Econo-Pac Q Cartridge
1836	Antibody Purification with the Econo-Pac Protein A Cartridge and the Econo System
1837	Enzyme Purification with the Econo-Pac Q Cartridge

## Chromatography Instruments and Accessories

---

Bulletin Number	Product Information
--------------------	---------------------

---

### Low Pressure Chromatography Systems

1605	Econo System Technical Specifications
1703	Automated Econo System Components
1730	Purification Systems

### Low Pressure Chromatography Detectors

1793	Econo Gradient Monitor
------	------------------------

### Fraction Collectors

1823	Model 2128 Fraction Collector Recorders
1780	Model 1327 Recorder

**BIO-RAD**

**Bio-Rad  
Laboratories**

*Life Science  
Group*

**Bio-Rad Laboratories Main Office**, 2000 Alfred Nobel Drive, Hercules, California 94547, Ph. (510) 741-1000, Fx. (510) 741-1060 •

**Eastern Regional Office**, 85A Marcus Dr., Melville, New York 11747, Ph. (516) 756-2575, Fx. (516) 756-2594 •

**Also in: North Ryde, Australia**, Ph. 02-805-5000, Fx. 02-805-1920 • **Wien, Austria**, Ph. 0222-877 89 01, Fx. 0222-876 56 29 • **Nazareth, Belgium**,

Ph. 091-85 55 11, Fx. 091-85 65 54 • **Mississauga, Canada**, Ph. (416) 624-0713, Fx. (416) 624-3019 • **Beijing, China**, Ph. 2563146, Fx. 2564308 •

**Paris, France**, Ph. 01-49 60 68 34, Fx. 01-46 71 24 67 • **München, Germany**, Ph. 089-318 84 0, Fx. 089-318 84 100 • **Milano, Italy**, Ph. 02-21609.1,

Fx. 02-21609.399 • **Tokyo, Japan**, Ph. 03-3534-7515 Fx. 03-3534-8027 • **Veenendaal, The Netherlands**, Ph. 08385-40666, Fx. 08385-42216 • **Auckland,**

**New Zealand**, Ph. 09-443 3099, Fx. 09-443 3097 • **Kowloon, Hong Kong**, Ph. 7893300, Fx. 7891257 • **Upplands Väsby, Sweden**, Phone 46 (0) 8 590-73489,

Fx 46 (0) 8 590-71781 • **Madrid, Spain**, Ph. (91) 661 70 85, Fx. (91) 661 96 98 • **Glattbrugg, Switzerland**, Ph. 01/810 16 77, Fx. 01/810 19 33 • **Hemel**

**Hempstead, United Kingdom**, Ph. 0800 181134, Fx. 0442 259118