

Review

Production of disulfide-bonded proteins in *Escherichia coli*

Mehmet Berkmen*

New England Biolabs, 240 County Road, Ipswich, MA 01938, USA

ARTICLE INFO

Article history:

Received 19 October 2011
and in revised form 24 October 2011
Available online 7 November 2011

Keywords:

Disulfide bond
Escherichia coli
Dsb
Origami
SHuffle
FA113
Oxidative protein folding

ABSTRACT

Disulfide bonds are covalent bonds formed post-translationally by the oxidation of a pair of cysteines. A disulfide bond can serve structural, catalytic, and signaling roles. However, there is an inherent problem to the process of disulfide bond formation: mis-pairing of cysteines can cause misfolding, aggregation and ultimately result in low yields during protein production. Recent developments in the understanding of the mechanisms involved in the formation of disulfide bonds have allowed the research community to engineer and develop methods to produce multi-disulfide-bonded proteins to high yields. This review attempts to highlight the mechanisms responsible for disulfide bond formation in *Escherichia coli*, both in its native periplasmic compartment in wild-type strains and in the genetically modified cytoplasm of engineered strains. The purpose of this review is to familiarize the researcher with the biological principles involved in the formation of disulfide-bonded proteins with the hope of guiding the scientist in choosing the optimum expression system.

© 2011 Elsevier Inc. All rights reserved.

Contents

Overview	240
On the nature of disulfide bonds	241
Does my protein of interest have disulfide bonds?	242
Conservation and number of cysteines	242
Extra-cytoplasmic location of the protein	243
Production of disulfide-bonded proteins in <i>E. coli</i>	243
Periplasmic production	243
Oxidation: DsbAB	243
Reduction/isomerization	244
Alternative mechanisms of periplasmic disulfide bond formation	246
Alternative oxidoreductases	246
Engineered oxidoreductases	246
Fusion partners	246
Cytoplasmic production	247
Alternative mechanisms of cytoplasmic disulfide bond formation	248
Conclusions	248
Acknowledgements	248
References	248

Overview

The study of protein disulfide bond formation began half a century ago with Anfinsen's seminal work on the folding of bovine

pancreatic ribonuclease (RNaseA).¹ Anfinsen and colleagues demonstrated that a fully denatured RNaseA having all three of its disulfide bonds reduced, could re-fold *in vitro* back to its active correctly folded disulfide-bonded state, independent of any help from

* Fax: +1 978 921 1350.

E-mail address: berkmen@neb.com

¹ Abbreviations used: ER, endoplasmic reticulum; Trx1, thioredoxin 1; ROS, reactive oxygen species; Dsb, disulfide bond; GAPDH, glyceraldehyde-3-phosphate dehydrogenase; PhoA, oxidize the alkaline phosphatase; RNR, ribonucleotide reductase.

cytoplasmic constituents [1]. Their conclusion was that the information present within a polypeptide was sufficient for it to achieve its final correctly folded state [2]. This led to the erroneous conclusion that disulfide bonds are formed spontaneously within a living cell. For the next three decades, their work sealed the notion that an electron acceptor such as oxygen was sufficient for catalyzing disulfide bonds *in vivo*. This dogma was overturned in 1991 with the discovery of a periplasmic enzyme from *Escherichia coli* required for catalyzing disulfide bonds [3]. This discovery led to a slew of investigations using several model organisms, resulting in today's detailed and sophisticated understanding of the biochemical and biophysical processes that govern the formation (oxidation), breaking (reduction) and shuffling (isomerization) of disulfide bonds within a polypeptide *in vivo*. Several excellent reviews have summarized the latest findings both in prokaryotes [4–6] and in eukaryotes [7–10].

Despite the advances in eukaryotic expression systems, *E. coli* remains a popular host for recombinant protein production both in research and in biotechnological industry. For example, of the 58 biopharmaceuticals products approved from 2006 to 2010, 17 are produced in *E. coli*, 32 are produced in mammalian cell lines (mainly Chinese hamster ovary; CHO) and four are produced in *Saccharomyces cerevisiae*, transgenic animals, or via direct synthesis [11]. The production of proteins to high yields remains a process of trial and error. Given an uncharacterized protein, researchers have few predictive tools to choose the correct host, expression system and expression conditions. The numerous possible post-translational modifications that proteins can undergo [12] increase the chances of failure at expressing a soluble active protein. Researchers usually resort to trying as many expression solutions as possible within their allocated time and resources. *E. coli* is often the first host of choice for most researchers, as overproduction and purification of a recombinant protein from *E. coli* can be faster,

cheaper, and easier than from other organisms. Furthermore, a myriad of tools have been developed for the expression of proteins in *E. coli* and a large body of information on protein folding solutions is available.

This article will focus on reviewing the current understanding of the processes that regulate the formation of disulfide bonds within the model prokaryotic host *E. coli*. Emphasis will be given to the utilitarian application of this knowledge to furthering the capacity to heterologously express multi-disulfide-bonded proteins in *E. coli*.

On the nature of disulfide bonds

Disulfide bonds are formed by the oxidation of thiol groups (SH) between two cysteine residues resulting in a covalent bond. Disulfide-bonded proteins are much more abundant than previously appreciated. Analysis of the human genome has predicted that more than half of the predicted proteins that are destined for the endoplasmic reticulum (ER) and beyond acquire disulfide bonds [13]. In the context of protein folding, disulfide bonds can be reduced, oxidized or isomerized. These processes require an oxidoreductase to catalyze an electron transfer event, during which a short-lived disulfide-bonded complex forms between the substrate and the enzyme (Fig. 1). All such oxidoreductases contain a thioredoxin fold with a CxxC active site motif, where x is any amino acid. Many factors determine whether, *in vivo*, an oxidoreductase is an oxidase or a reductase. These factors include the relative stabilities of the enzyme's reduced and oxidized states, the compartment in which the enzyme resides, and to some extent the amino acids within the enzyme's active site. Reductases, such as thioredoxin, are usually more stable when their active site cysteines are oxidized compared to when they are reduced [14] and vice versa for

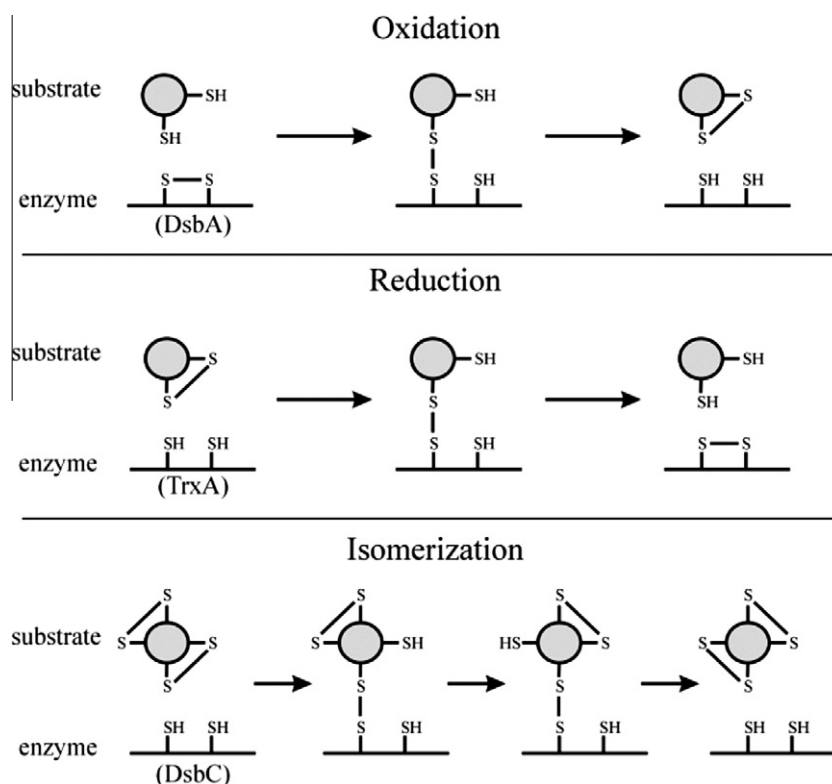

Fig. 1. Thiol-disulfide bond exchange. Schematic representation of electron transfer between a substrate protein (grey ball) and an oxidoreductase (black line) resulting in oxidation, reduction or isomerization of disulfide bonds.

oxidizing enzymes such as DsbA [15]. For example, a cytoplasmic reductase such as thioredoxin 1 (Trx1) can act as an oxidase when expressed in the periplasm, where it is decoupled from the reductases which maintain it in its reduced state [16]. Manipulating the amino acids near the active site pocket [17] or within the CxxC motif [18] can also have profound effects on the reducing vs. oxidizing activity of an oxidoreductase [19].

Disulfide bonds have multiple biologically significant functions. For example, disulfide bonds can play structural roles important for the folding and stability of a protein. Disulfide bonds can also act as signals of the redox environment; they can be readily oxidized or reduced, thereby changing the conformation of the protein in response to the redox state of the environment. Finally, in the context of the active site of an oxidoreductase, cysteines can donate or accept electrons, catalyzing either the oxidation or reduction of disulfide bonds in a substrate protein. It is therefore important for the researcher to be aware of the types of disulfide bonds that exist in proteins: structural, signaling and catalytic.

Structural disulfide bonds decrease the possible number of conformations for a given protein, resulting in decreased entropy and increased thermostability [20]. For some proteins, disulfide bonds are critical for their folding as reducing their disulfide bonds can result in denatured inactive protein [21]. For other proteins, disulfide bonds are not essential for their folding; instead they increase the proteins' stability [22,23]. Recombinant expression of proteins in *E. coli* sometimes results in the formation of aberrant disulfide bonds. One labor-intensive solution to this problem is to mutate the non-essential cysteines that form the aberrant disulfide bonds to produce greater yields of correctly oxidized soluble protein [24]. A more attractive general solution to this problem would be to express the protein in a mutant *E. coli* strain background engineered to possess alternative mechanisms of oxidative folding.

Proteins residing outside the protective chaperone-rich environment of the cytoplasm are especially susceptible to environmental abuse and are therefore usually rich in disulfide bonds to increase their stability. Extra-cytoplasmic and surface associated proteins are common therapeutic targets, and consist exclusively or partially of disulfide-bonded proteins [25]. Furthermore, more stable versions of industrially relevant proteins have been engineered by inserting cysteines at specific locations to allow disulfide bonds to form [26,27]. In nature, hyperthermophilic organisms use the stabilizing effects of disulfide bonds to increase the thermostability of their proteome. Crenarchaeal organisms thrive at temperatures 75° C to 105° C and have proteomes with enriched cysteine content, possibly due to the higher frequency of disulfide-bonded proteins [28]. For example, the enzyme adenylosuccinate lyase has three disulfide bonds in the hyperthermophilic crenarchaeal *Pyrobaculum aerophilum*, but lacks disulfide bonds in a mesophilic organism [29]. Similar observations have been made for proteins from other thermophilic organisms [30–32], including the DNA polymerase from *Thermococcus gorgonarius* [33]. It should also be noted that structural cysteines can also be involved in coordinating metal ions such as iron [34], mercury [35], zinc [36] or binding prosthetic groups such as hemes [37] or FAD [38].

Signaling disulfide bonds are responsible for conveying the redox state of their environment via conformational changes incurred in the protein, during the oxidation and reduction of its redox-sensitive disulfide bond(s). Due to their reversible nature, signaling disulfide bonds are sensitive to their redox environment, and thus tend to be transient in nature. For example, the transcription factor OxyR which responds to cellular hydrogen peroxide has one signaling disulfide bond that senses reactive oxygen species (ROS) within the cytoplasm. Upon exposure to ROS, a transient disulfide bond is formed, activating OxyR to transcriptionally initiate the oxidative stress response. Removal of the oxidative stress results in the reduction of the disulfide bond, returning OxyR back to its quies-

cent state [39]. Other bacterial examples of signaling disulfide bonds are found in the ArcAB two-component system which senses and responds to changes in respiratory growth conditions of the cell [40] and the cytoplasmic anti-sigma factor RsrA, responsible for activating the cytoplasmic oxidative stress response [41].

Catalytic disulfide bonds are involved in redox reactions and are found in all oxidoreductases. Catalytic disulfide bonds are usually found within the classic CxxC active site motif. Oxidoreductases that are involved in the oxidation of cysteines must have their active site cysteines maintained in their oxidized, disulfide-bonded state; one example of such an enzyme is the periplasmic DsbA [42]. Conversely, oxidoreductases that are involved in the reduction of disulfide bonds must have their active site cysteines maintained in their reduced, thiolate states; examples of such enzymes include the cytoplasmic oxidoreductases thioredoxin and glutaredoxin [43]. The correct redox state of an oxidoreductase is usually maintained by a partner protein (see Section c for more details).

It is sometimes difficult to predict whether an oxidoreductase is a dedicated oxidase or a reductase. One clue for the role of an oxidoreductase comes from the enzyme's cellular location. Oxidoreductases involved in the formation of disulfide bonds are usually found in extra-cytoplasmic compartments, such as the periplasm in gram negative prokaryotes [6] and the endoplasmic reticulum in eukaryotes [9]. Recent findings have also elucidated specific oxidases in the inter-membrane space of mitochondria [44,45] and the thylakoids of chloroplasts [46]. Furthermore, the redox environment in which the oxidoreductase is expressed will affect the redox state of the catalytic disulfide bond. For example, the cytoplasmic reductase TrxA whose active site cysteines are maintained in their reduced state will convert partially to an oxidase, when expressed in the periplasm *in vivo* [47]. Additionally, amino acids within its active site [19,48] and those of other oxidoreductases that it interacts with, also play a significant role in maintaining the redox state of TrxA's catalytic disulfide bonds [49,50].

Does my protein of interest have disulfide bonds?

When expressing a protein with unknown folding requirements, a researcher is challenged to find the appropriate expression host and conditions, especially if the protein requires post-translational modifications such as disulfide bonds. It is therefore critical to know whether a given protein contains disulfide bonds. Web based servers [51,52] and algorithms [53,54] claim they can predict the presence of disulfide bonds with up to 87% confidence [55]. However, such prediction programs are not yet widely used. As an alternative simple method, I suggest that if a protein of interest contains an even number of conserved cysteines and is predicted to be extracytoplasmic, then the protein likely contains disulfide bonds. The reasoning behind this is outlined below.

Conservation and number of cysteines

It was observed early on [56,57] that cysteine is one of the most reactive amino acids and therefore one of the least abundant amino acids within proteins [58]. In fact in *Drosophila*, UGU coding for cysteine is the most infrequently used codon [59]. This feature of cysteines is advantageous when used as a predictor of biological function as their presence is less likely due to random mutation, but more so a representation of their biological roles. Highly conserved cysteines are often indicative of structural disulfide bonds, especially if the conservation is within proteins from diverse organisms. Since a disulfide bond requires the pairing of two cysteines, generally proteins expressed in oxidative environments tend to have even numbered cysteines. This correlation was used to predict the presence of disulfide-bonded proteins in the cyto-

plasm of various thermophilic organisms [28,60] and the periplasm of prokaryotes [61].

Extra-cytoplasmic location of the protein

In prokaryotes and eukaryotes, disulfide bond formation is compartmentalized to non-cytoplasmic locations such as the periplasm or ER, respectively. Proteins that require disulfide bonds for their folding are secreted to these compartments and therefore harbor an N-terminal signal peptide. There are several web based algorithms that can predict the presence of a signal peptide to high levels of confidence [62,63]. However, not all periplasms are oxidative. For example, the periplasm of the anaerobic *Bacteroides* is predicted to be a reducing compartment [49,64]. In summary, a secreted protein with conserved even-numbered cysteines is predicted to contain disulfide bonds.

Production of disulfide-bonded proteins in *E. coli*

Periplasmic production

The cytoplasm of wild-type *E. coli* is not permissive to the formation of disulfide-bonded proteins due to the presence of numerous reductases and reducing agents such as glutathione. A protein that requires disulfide bonds for its folding must be secreted to the

periplasm. There, a set of cell envelope proteins (named Dsb for **disulfide bond**) catalyze the formation and correction of disulfide bonds. The Dsb system has been studied in great detail for the last two decades and several comprehensive reviews have been written on this subject [6,65–67]. This section will give a brief summary of these findings.

Oxidation: DsbAB

In *E. coli*, the protein machinery that catalyzes the formation of disulfide bonds is localized in the periplasm (Fig. 2). DsbA is a 21 kDa monomeric protein whose *in vivo* and *in vitro* properties have been extensively characterized. DsbA contains the classic thioredoxin fold [68] and a CxxC active site motif. DsbA is a potent oxidase [69], catalyzing the formation of disulfide bonds as a substrate protein enters the periplasm [17]. After donating its disulfide bond to the substrate, DsbA becomes reduced and must be re-oxidized back to its active oxidized state by the inner membrane protein DsbB [42]. DsbB, in turn, donates the electrons to either ubiquinone during aerobic growth or to menaquinone during anaerobic growth [70].

DsbA is an indiscriminately powerful oxidase and will catalyze the formation of disulfide bonds, even in proteins that naturally do not have disulfide bonds. For example, when the normally reduced beta-lactamase CcrA from *Bacteroides fragilis* is expressed in the periplasm of *E. coli*, its cysteines are oxidized rendering the protein

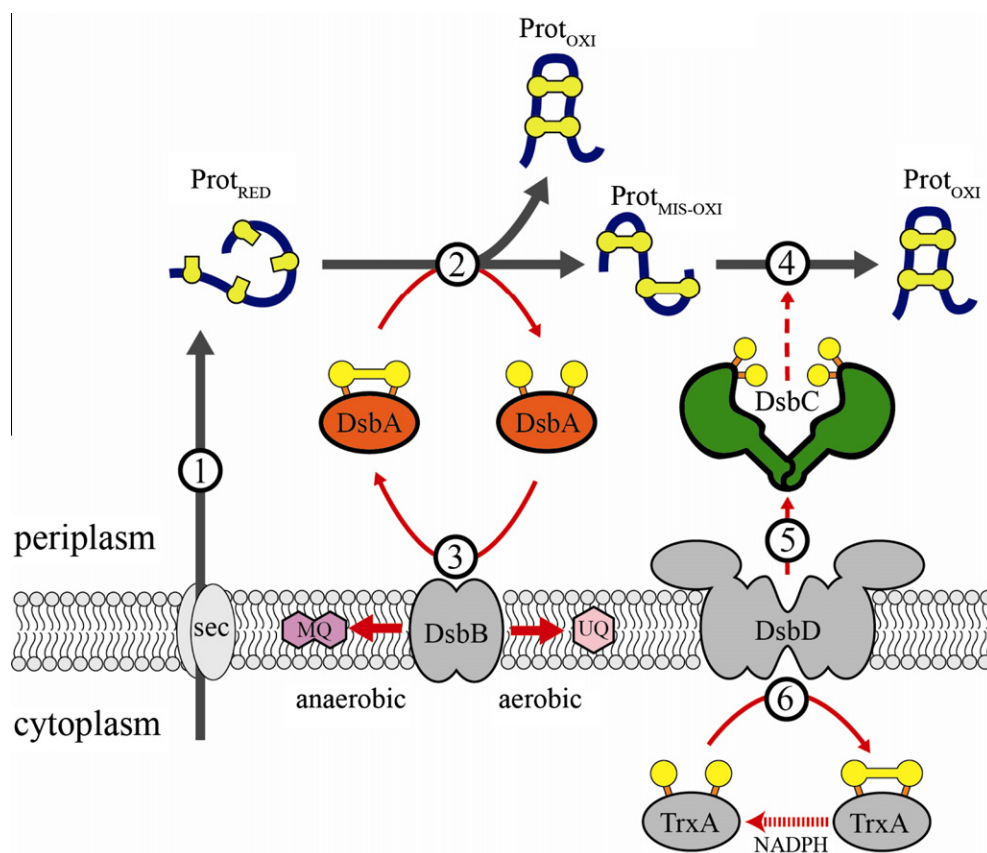

Fig. 2. Periplasmic disulfide bond formation. ① A substrate protein which requires disulfide bonds for its folding is exported to the periplasm in its reduced non-disulfide-bonded state (Prot_{RED}), usually via the *sec* pathway. ② DsbA forms a disulfide-bonded complex with its reduced substrate resulting in the formation of a disulfide bond in the substrate protein (Prot_{OXI}) and the reduction of DsbA's active site cysteines. ③ DsbA is re-oxidized by the inner membrane protein DsbB, which donates the electrons it has received from DsbA either to ubiquinone (UQ) in aerobic conditions or to menaquinone (MQ) in anaerobic conditions. ④ If the substrate protein is mis-oxidized ($\text{Prot}_{\text{MIS-OXI}}$) by DsbA, the misfolded protein is recognized by DsbC and is either isomerized to its native state or reduced, allowing DsbA to have another chance at correctly oxidizing the protein. ⑤ DsbC is maintained in its active reduced state by the inner membrane protein DsbD. ⑥ DsbD receives its electrons from the cytoplasmic thioredoxin (TrxA) which ultimately receives its electrons from the cytoplasmic pool of NADPH. Cysteines are represented as yellow balls in their reduced state or as sticks in their disulfide-bonded state. Grey arrows show products obtained after each step, whereas red arrows represent electron flow. (For interpretation of the references to colour in this figure legend, the reader is referred to the web version of this article.)

inactive [71]. Similarly, when cytosolic proteins whose cysteines are naturally maintained reduced are exported to the periplasm, they too become oxidized by DsbA and are misfolded [3].

Reduction/isomerization

DsbCD. Proteins that are mis-oxidized, and are therefore misfolded, may be isomerized back to their native disulfide-bonded state by DsbC [72,73] (Fig 2). DsbC is a 23 kDa homodimeric protein consisting of two domains, a thioredoxin and a dimerization domain, linked by a short alpha-helical strand [74]. The thioredoxin domain of DsbC contains four cysteines. The carboxyl-terminal cysteine pair forms a structural disulfide bond that is crucial for the stability of DsbC [75]. The amino-terminal cysteine pairs are part of the active site CxxC motif and are maintained in their reduced state by the inner membrane protein DsbD [76]. DsbD receives its reducing potential from cytoplasmic thioredoxin, which ultimately receives its electrons from the pool of NADPH [77].















Why are some proteins correctly oxidized by DsbA while others are not? Since DsbA rapidly and efficiently catalyzes disulfide bond formation as an unfolded protein is translocated into the periplasm [17], it has the tendency to oxidize cysteines in a consecutive manner [17,78]. Proteins that require non-consecutive disulfide bonds are thus often misfolded, and may be either degraded by periplasmic proteases or isomerized back to their correct oxidized state by DsbC. Table 1 shows a list of characterized proteins, their disulfide bond connectivity patterns, and their dependency on DsbC for

correct folding. Proteins such as Hcp having eight cysteines (four consecutive disulfide bonds) and therefore 105 possible disulfide-bonded states is correctly oxidized by DsbA [79], while MGSA with four cysteines (two non-consecutive disulfide bonds) and only three possible disulfide-bonded states, is not [80]. In general, proteins with consecutive disulfide bonds do not require DsbC while proteins with nonconsecutive disulfide bonds do. Although it is likely that exceptions to this correlation might exist in nature, this reviewer has yet to find a documented exception.

Disulfide bond isomerization is crucial for the production of nonconsecutive multi-disulfide-bonded proteins in the periplasm. Over-expression of DsbC in the periplasm can result in substantial improvement in yields of correctly folded proteins [81–86]. Our current understanding of the *in vivo* mechanism of disulfide bond isomerization remains limited. Two mechanistic questions about DsbC remain elusive and are central to our understanding of disulfide bond isomerization *in vivo*: How does DsbC discriminate between correctly folded proteins and those that are mis-oxidized? How does DsbC isomerize a mis-oxidized protein back to its native state?

Clues to DsbC's substrate recognition were eventually found upon solving its crystal structure. Dimerization of the two monomers of DsbC results in a "V" shaped protein with an uncharged cleft 38 Å wide [74]. Another folding chaperone, trigger factor, with a hydrophobic cleft of similar dimensions has been proposed to accommodate globular protein domains up to a molecular weight of approximately 15 kDa [87]. It is hypothesized that the hydro-

Table 1
Relationship between disulfide bond pattern and folding dependence on DsbC. Table summarizing the drop in either activity or yield of proteins when expressed in cells lacking *dsbC*. Results are shown as % activity or yield relative to wild type (*dsbC*⁺) cells. Schematic representation of the disulfide bond pattern depicted as yellow balls from amino terminus (left) to carboxyl terminus (right). Shaded boxes indicate proteins with consecutive disulfide bond patterns which are not dependent on DsbC.

Protein	Disulfide bond pattern	Relative activity/yield in $\Delta dsbC$ (%)	Ref.
PhoA Alkaline phosphatase		100	[153]
hGH Human growth hormone		100	[80]
Agp Glucose-1 phosphatase		100	[78]
Anti CD-18 Human fab		100	[80]
Hcp <i>H. pylori</i> cysteine-rich protein B		100	[79]
MGSA Melanocyte growth stimulating factor		50	[80]
IGF-I Interferon like growth factor I		50	[80]
MepA Murein hydrolase		25	[154]
BPTI Bovine pancreatic trypsin inhibitor		20	[76]
AppA Acid phosphatase		20	[78]
RBI Ragi bi-functional inhibitor		7	[84]
RNaseI Periplasmic nuclease		0	[154]
tPA Tissue plasminogen activator		0	[82]
Urokinase		0	[76]

phobic cleft of DsbC discriminates against interacting with correctly folded proteins whose hydrophobic amino acids reside sheltered within the core of the protein. Instead, DsbC may prefer interacting with misfolded proteins whose hydrophobic core is exposed due to mis-oxidation. Also, based on analysis of protein crystal structures, correctly oxidized cysteine pairs are usually inaccessible and buried within the protein while mis-oxidized pairs may be exposed and accessible to DsbC.

DsbC's hydrophobic cleft may assist folding of proteins, even those that lack disulfide bonds altogether. For example, purified DsbC helps refold *in vitro* three different substrate proteins: non-disulfide-bonded D-glyceraldehyde-3-phosphate dehydrogenase (GAPDH), lysozyme [88] and single-chain antibody fragments [89]. This chaperone property of DsbC is dependent on the dimerization of DsbC [90] and is independent of its redox-active cysteines. Other proteins with similar hydrophobic clefts are known to be folding chaperones, such as maltose binding protein [91] and trigger factor [92]. However, no direct evidence has thus far shown the role of the hydrophobic cleft in the ability of DsbC to bind and refold misfolded proteins.

Although disulfide bond isomerization has been studied *in vitro* using the model protein BPTI [93], the *in vivo* mechanism remains in dispute. Currently there are two *in vivo* models for how DsbC facilitates disulfide bond isomerization. (i) The isomerization model and (ii) the cycles of oxidation/reduction model. Both models have the same initial step of a reduced DsbC attacking a disulfide bond within the protein and forming a mixed-disulfide-bonded complex. The subsequent steps of resolving this complex are different for the two different mechanisms (Fig. 3).

(i) The first isomerization model is based on the observation that DsbC can shuffle the disulfide bonds of a mis-oxidized protein *in vitro* within the appropriate redox buffer in the absence of any other accessory protein [93]. In this model, the mixed-disulfide-bonded DsbC-protein complex is resolved by a nucleophilic attack from another disulfide bond within the mis-oxidized protein, resulting in the shuffling of disulfide bonds. The isomerization of disulfide bonds is guided by the substrate protein's folding landscape and results in the target protein's most thermodynamically stable, fully folded and oxidized state. The final nucleophilic attack would return DsbC back to its reduced state.

(ii) The second oxidation/reduction model is based on the observation that DsbC displays strong *in vitro* reductase activity, equivalent to the reductase activity of cytoplasmic thioredoxin [94]. Should the mixed-disulfide-bonded complex between DsbC and the mis-oxidized protein not be resolved by a nucleophilic attack from the substrate protein, then DsbC can resolve itself by reducing the disulfide bond, leaving it in an oxidized state. This would result in the reduction of the wrong disulfide bond, allowing for subsequent re-oxidation by DsbA. This separation by reduction of the protein-DsbC complex is essential for DsbC to resolve itself from a non-productive complex, when the protein is too misfolded to be isomerized. Otherwise, one could imagine titration of functional DsbC from the periplasm, under conditions where there is a large number of misfolded proteins. This model was shown to be plausible *in vivo*; DsbC can be complemented *in vivo* by expression of a disulfide bond reductase. Correct folding and oxidation of a natural substrate of DsbC was obtained, in the absence of any detectable disulfide bond isomerase activity [49].

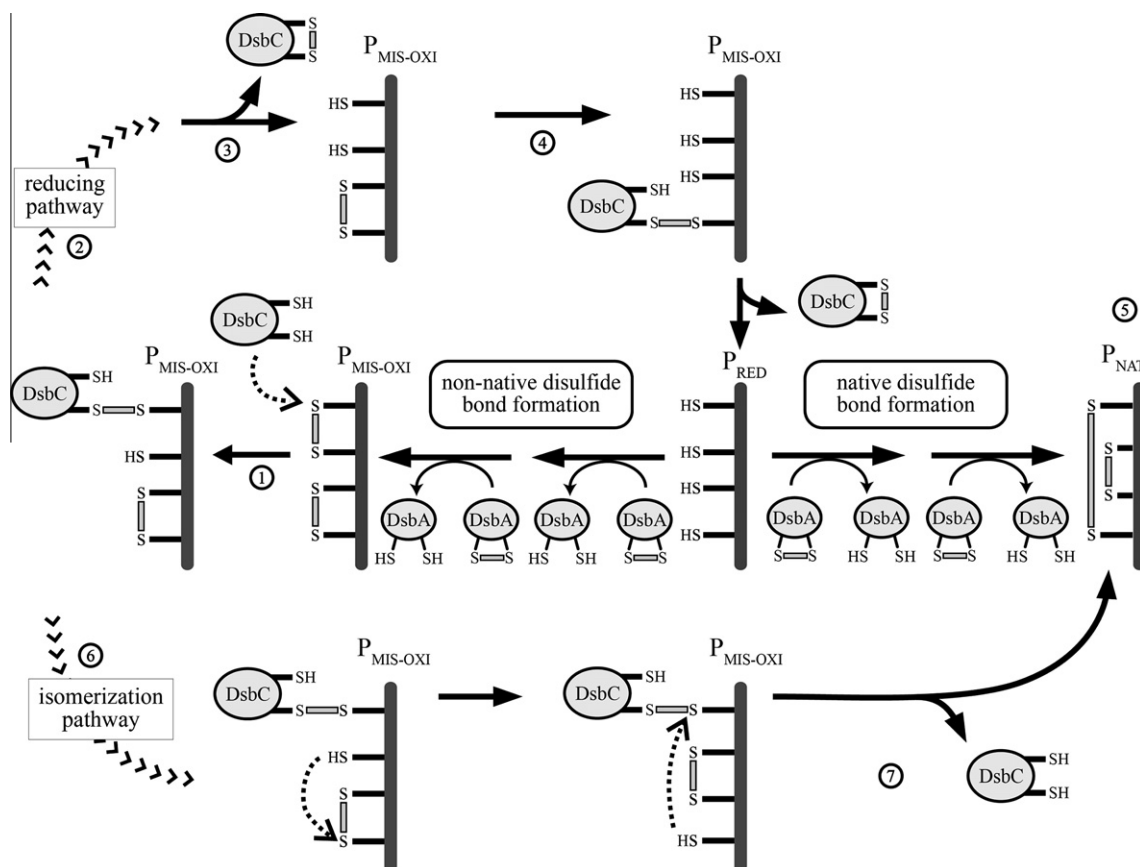

Fig. 3. The two *in vivo* models of disulfide bond isomerization. ① A reduced protein (P_{RED}) is mis-oxidized ($P_{MIS-OXI}$) by DsbA. The misfolded protein is recognized by DsbC forming mixed-disulfide-bonded complex. ② In the reducing pathway, ③–④ DsbC reduces the wrongly formed disulfide, ⑤ allowing for DsbA to have another chance at correctly oxidizing the protein. ⑥ In the isomerization pathway, DsbC acts as a true isomerase allowing for the shuffling of the disulfide bonds, ⑦ resulting in no change in the redox state of DsbC or the substrate protein.

Alternative mechanisms of periplasmic disulfide bond formation

Successful folding of a recombinant protein to high yields is both highly unpredictable and dependent on the expression conditions and substrate protein. It is therefore advantageous to have multiple strain backgrounds that promote oxidative folding, enabling the researcher to find the optimum system for expressing active correctly folded protein. This section will briefly review the various mutant strains that allow for the production of disulfide-bonded proteins in the periplasm of *E. coli*.

Alternative oxidoreductases

Elucidation of the periplasmic disulfide bond forming machinery in *E. coli* has allowed researchers to circumvent the native *dsb* pathway in search of novel mechanisms of forming disulfide bonds. Some genetic selections for chromosomal mutations that restored function in the *dsb* pathway resulted in simple up regulation of other *dsb* genes [95,96]. Here, we describe other selections systems that sought to replace the function of a Dsb protein with another oxidoreductase either from *E. coli* or for from other organisms.

One obvious candidate that might replace DsbC is *E. coli*'s second periplasmic oxidoreductase DsbG. DsbG is homologous to DsbC with 49% amino acid sequence similarity and 30% identity. Its crystal structure reveals a very similar architecture to DsbC but its protein binding cleft is larger and less hydrophobic [97]. Even though DsbG can catalyze disulfide bond isomerization *in vitro* [98] and has significant chaperone activity [99], no *in vivo* substrate that requires its disulfide bond isomerase activity has been identified. When over-expressed from a plasmid, DsbG can complement a *dsbC* null strain by assisting the folding of BPTI [100] and AppA and by activating P1 lysozyme via intramolecular thiol-disulfide isomerization (141) (data not shown). However, DsbG's natural role is likely to act as a reductase, restoring cysteines that have been oxidized to sulfenic acid back to their reduced thiolate state [101]. Due to the differences in substrate specificities between DsbC and DsbG, highly expressed DsbG in theory may assist in the folding of disulfide-bonded proteins which DsbC fails to fold. This difference between DsbC and DsbG was used to isolate mutant DsbG's that could complement the copper sensitivity of *dsbC* null strains [102].

Scientists have also successfully identified eukaryotic proteins that can complement DsbA function. In eukaryotes, disulfide bond formation and isomerization is catalyzed by a single enzyme called protein disulfide bond isomerase (PDI) [103]. Overexpression of rat PDI in the periplasm of *E. coli* complements a *dsbA* null strain, increasing the yield of BPTI sixfold [104]. Overexpression of human PDI also complements a *dsbA* strain, increasing the yields of Fab fragment [105] and pectate lyase C fivefold [106]. Thus, expression of PDI in *E. coli* may improve the yields of certain substrate proteins.

Engineered oxidoreductases

In addition to using native oxidoreductases, attempts have been made to engineer and select mutants of various oxidoreductases to replace Dsb protein function. Here we describe several of the alternative proteins discovered.

Cytoplasmic oxidoreductases have also been shown to functionally replace Dsb function. For example, when exported to the periplasm, the cytoplasmic thioredoxin TrxA was functionally converted from a disulfide bond reductase to an oxidase [16]. However, periplasmic TrxA in a *dsbA*- strain was able to oxidize the alkaline phosphatase (PhoA) such that PhoA activity was only 22% of wild type levels. Further optimization identified a mutant, TrxA_G74S [50], that interacted better with DsbB [49], restoring PhoA activity to levels similar to wild type.

In an attempt to identify *de novo* pathways and circumvent the DsbA/DsbB oxidative pathway, Masip et al. selected an exported mutant thioredoxin that restored a double null *dsbA dsbB* phenotype [107]. The selection scheme required the mutant thioredoxin to be folded in the oxidizing cytoplasm of a *trxB gor* strain (see below for more details on a *trxB gor* strain) and be exported to the periplasm via the TAT pathway. Surprisingly, the mutant thioredoxin formed a dimeric iron-sulfur cluster protein and was able to oxidize periplasmic PhoA independent of *dsbA* and *dsbB*. However, restoration of the oxidizing pathway yielded only 40% of wild type levels of PhoA. Another approach to circumventing the dependence on DsbA/DsbB for the oxidative folding of proteins was to export the *E. coli* glutaredoxin Grx3 to the periplasm [108]. Expression of periplasmic Grx3 resulted in PhoA activity at approximately 60% of wild type levels. Intriguingly, disulfide bond formation by periplasmic Grx3 was dependent on the cytoplasmic production of glutathione. Exogenously added glutathione increased the level of PhoA activity to 75% of wild type cells in the presence of periplasmic Grx3.

Another approach utilized the architecture of DsbC as a scaffold to engineer novel disulfide bond isomerases. DsbC is a dimeric protein where each monomer contains a thioredoxin domain and a dimerization domain. Dimeric DsbC cannot act as an oxidant as it does not interact with DsbB due to steric hindrance. Selection of mutant DsbC proteins that can complement a *dsbA* strain resulted in monomeric DsbC that contain mutations in the dimerization domain [109]. The monomeric DsbC interact with DsbB and oxidize PhoA activity to 50% of wild type levels. Alternatively, deleting amino acid residues from the linker domain of DsbC also allows it to interact with DsbB, and thus function as an oxidase [110]. Finally, in an attempt to replicate the architecture of DsbC, Arredondo et al. engineered novel chimeric oxidoreductases utilizing the dimerization domain of proline *cis/trans* isomerase FkpA, fused to DsbA [111]. These chimeric constructs were able to complement the dependence of vtPA on DsbC up to 80% of wild type (DsbA+/DsbB+) levels.

The two amino acid residues in between the two cysteines of the active site (CxxC) are known to act as 'rheostats', calibrating the activity of an oxidoreductase from a reductase to an oxidase [18]. Changing these active site amino acids has significant effects on the activity of TrxA [19], DsbA [48], DsbB [112] and PDI [113]. More importantly, for the purposes of protein production, DsbC variants that contain alterations in the dipeptide sequence of its active site residues, increase the yield of mouse urokinase up to fivefold [114].

Fusion partners

In general, DsbA interacts with largely unfolded polypeptides as they are entering the periplasm. A hydrophobic groove near the active site of DsbA has been proposed to be its substrate binding cleft [115] and DsbA displays some chaperone activity *in vitro* [116]. The ability of PDI, DsbA and DsbC to bind to unstructured polypeptides via their hydrophobic binding clefts has been used to improve protein folding and disulfide bond formation by constructing fusion substrate proteins to either DsbA [117,118], DsbC [83], PDI [119–121] or TrxA [122,123]. Plasmid expression vectors which permit cloning of one's gene of interest as a fusion protein to DsbA (pET-39), DsbC (pET-40) or TrxA (pET-32) are currently available from Novagen.

These results highlight the interchanging roles of disulfide bond oxidoreductases from reductases to isomerases to oxidases. The function of one oxidoreductase can be readily converted to another by manipulating the compartments it is expressed in and by introducing subtle mutations that have profound effects on its activity, architecture and interacting protein partners.

Cytoplasmic production

The cytoplasm of wild type *E. coli* is not amenable to the production of disulfide-bonded proteins [124]. Although disulfide bonds may form transiently, they are quickly reduced by the numerous reductases and small molecule reductants present in the cytoplasm. This 'reducing environment' is maintained by the glutaredoxin and thioredoxin pathways (Fig. 4) [125]. Both pathways receive their reducing potential from the cytoplasmic pool of NADPH. In the case of the thioredoxin pathway, thioredoxin reductase (*trxB*) maintains two thioredoxins in their reduced state, Trx1 (*trxA*) and Trx2 (*trxC*) [126]. These thioredoxins in turn reduce cytoplasmic proteins which might form disulfide bonds (either by oxidative damage or through their catalytic activity) back to their thiolate state.

An alternative pathway for maintaining a reducing cytoplasm is the glutaredoxin pathway. Glutathione reductase reduces two enzymes, GshA and GshB, which are responsible for synthesizing reduced glutathione (GSH). Glutathione is a small tripeptide (L-γ-glutamyl-L-cysteinylglycine) whose primary role is to act as the major component of the cytoplasmic redox buffer. At intracellular concentrations approaching 5 mM, most glutathione is reduced and not in its disulfide-bonded dimeric form, GSSG. In the cytoplasm of *E. coli*, the ratio of GSSG:GSH is ~1:200 [127]. GSH also directly reduces disulfide-bonded proteins, forming a GSH-protein complex. The complex is resolved by one of several glutaredoxins (Grx1, Grx2 and Grx3) that reduce the protein and oxidize glutaredoxin. The oxidized glutaredoxin is recycled back to its active reduced state by GSH [128].

Ribonucleotide reductase (RNR) is an essential protein, whose cysteines become oxidized during its catalytic cycle and requires either the thioredoxin or the glutaredoxin pathway to recycle it back to its active reduced state [129,130]. Since the reducing capacity of either the thioredoxin or the glutaredoxin pathway is sufficient to reduce RNR, genetic disruption of either pathway is tolerated by *E. coli*. However, cells are not viable when both pathways are disrupted. Deletion of both *trxB* and *gor* leads to lethality but can be suppressed by a mutation in the peroxidase AhpC. This mutant AhpC* has lost its peroxidase activity but has gained disulfide bond reductase activity [131]. AhpC* had increased capacity to

resolve GSH-Grx complexes *in vitro*; presumably, this increased capacity results in sufficient amounts of reduced Grx1 *in vivo* to restore viability [132]. However, in the absence of thioredoxin reductase (*trxB*), the two thioredoxins in *E. coli* (Trx1 and Trx2) accumulate in their oxidized forms enabling them to act as disulfide bond formation catalysts in a reversal of their normal function [123]. This final strain FÅ113 (*trxB*, *gor*, *ahpC**) has the remarkable capacity to catalyze disulfide bond formation in the cytoplasm [133]. FÅ113 is commercially available under the name Origami (Novagen) and has been used to express numerous disulfide-bonded proteins in the cytoplasm [134–139].

One drawback to using strains such as FÅ113 for the production of disulfide-bonded proteins is the lack of disulfide bond isomerization. If a protein is mis-oxidized in the cytoplasm of FÅ113, the protein remains mis-oxidized since the disulfide bond isomerase DsbC resides in the periplasm. Co-expression of DsbC in the cytoplasm can greatly enhance the amount of correctly oxidized proteins [85,86,133,140]. This is most likely due to DsbC's disulfide bond isomerase activity and not due to its weak oxidase activity [93,141], as DsbC is mostly in its reduced state in the cytoplasm of FÅ113 [133]. To generate an oxidative strain with disulfide bond isomerase capacity, a new protein expression strain named SHuffle (New England Biolabs) was recently engineered that expresses DsbC in the cytoplasm of a *trxB*, *gor*, *ahpC** strain. Since SHuffle's recent commercial release, it has been shown to successfully express a membrane protein U24 from human herpes virus [142].

Whether a protein requires the corrective action of DsbC for its oxidative folding depends strongly on the mechanism of disulfide bond formation. Disulfide bond formation in the periplasm is profoundly different than in the cytoplasm. In the periplasm, the majority of disulfide bond formation is catalyzed by DsbA which has been shown to occur co-translocationally as the unfolded polypeptide enters the periplasm [17]. This strongly favors the oxidation of cysteines in a consecutive manner (Table 1). In comparison, the mechanism and timing of disulfide bond formation in the cytoplasm of *trxB*, *gor* cells has not been studied in detail. Unlike the periplasmic entrance of polypeptides, there is significant folding of the nascent chain within the ribosome exit channel and at the exit pore in the cytoplasm [143]. The partial folding of the protein may result in the formation of the correct disulfide bonds,

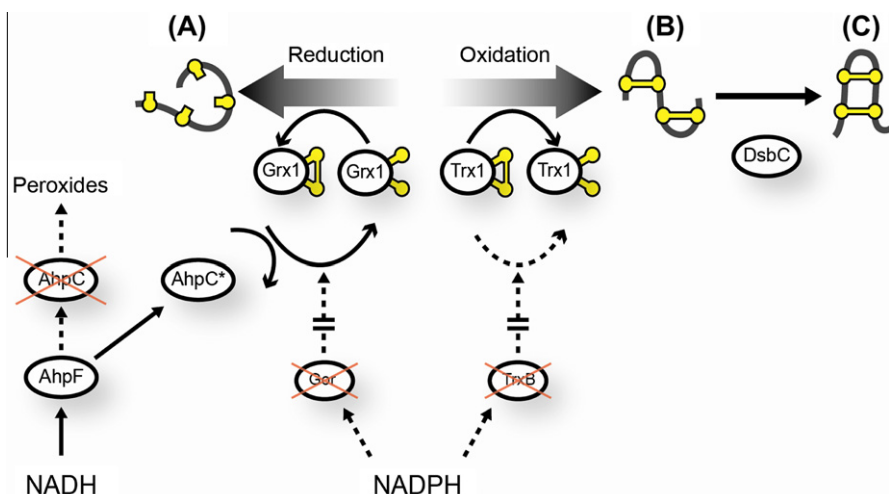

Fig. 4. Disulfide bond formation in the cytoplasm of SHuffle cells. Schematic representation of the redox pathways involved in the formation of disulfide bonds, in the cytoplasm of SHuffle cells. Disruption of the thioredoxin pathway (*TrxB*) and the glutaredoxin pathway (*Gor*) is lethal. Selection of *trxB*, *gor* suppressor resulted in mutant AhpC* which lost the ability to reduce peroxides but gained the ability to reduce Grx1. (A) Reduced Grx1 in turn can catalyze the reduction of proteins. Accumulation of oxidized thioredoxins such as Trx1 catalyzes the formation of disulfide bonds. (B) If the protein is mis-oxidized, it is isomerized to its native correctly folded state (C) by cytoplasmic DsbC. Disabled protein interactions are represented by dotted lines. For simplicity, other reductases (Grx2, Grx3 and Trx2) are omitted and only the redox state of cysteines (yellow balls) of Grx1 and Trx1 are indicated (oxidized = yellow balls are joined; reduced = ball). (For interpretation of the references in colour in this figure legend, the reader is referred to the web version of this article.)

making the protein less dependent on DsbC. This may explain why urokinase activity is fully dependent on DsbC when expressed in the periplasm but only 50% dependent when expressed in the cytoplasm (data not shown). Furthermore, the cytoplasm contains significant amounts of glutathione, which is involved in oxidative folding [144], while the concentration and redox state of periplasmic glutathione is significantly different [108,145]. These differences between the two compartments can have a significant effect on the final yields of a protein. For example, the yield of collagen prolyl 4-hydroxylase was ~20 times higher in the cytoplasm of FÅ113 (Origami) than in the periplasm of the corresponding BL21 wild type strain and ~10 times better than when expressed in insect cells [146].

Our current view on the mechanism of disulfide bond formation in the cytoplasm of FÅ113 is incomplete. For example in FÅ113 (*trxB*, *gor*, *ahpC**), it is unknown which of the two thioredoxins are involved in the oxidation of proteins. Trx1 and Trx2 share 66% similarity and 29% identity in their amino acid sequence and have very similar functions [123,147,148]. Trx1 levels are tenfold higher than Trx2 levels. However, Trx2 is under the regulation of OxyR and is expressed at much higher levels under oxidative stress conditions. Since under oxidative conditions, Trx2 remains reduced in comparison to Trx1, Trx1 may be specialized towards protection against oxidative damage. This may explain why 75% of the cytoplasmic PhoA activity in a *trxB* mutant strain is attributable to Trx1 while only 25% is due to Trx2 [123].

Alternative mechanisms of cytoplasmic disulfide bond formation

Secretion of a protein to the periplasm is problematic and may not result in the formation of the correct disulfide bonds [149]. Cytoplasmic oxidative folding of one's protein of interest in a *trxB*, *gor* strain is therefore an attractive solution. However, not all proteins expressed in a *trxB*, *gor* strain fold and form soluble active protein. For proteins that fail to fold properly in the cytoplasm of a *trxB*, *gor* strain, there are alternative strains to try. Recently Rudock and colleagues have shown that the co-expression of the mitochondrial inner-membrane FAD-dependent sulfhydryl oxidase Erv1p can promote the *de novo* formation of disulfide bonds in the cytoplasm [150]. While co-expression of Erv1p did not increase the yield of PhoA or AppA in the cytoplasm of a *trxB*, *gor* strain, remarkably Erv1p increased the yield of PhoA in wild type BL21 cells. Intriguingly, co-expression of Erv1p along with DsbC resulted in a threefold increase in the activity of AppA, a natural substrate of DsbC [78]. Thus, disulfide bond formation is not purely a result of the redox environment (i.e., the oxidizing periplasm) but a result of the presence of the appropriate disulfide bond-forming catalysts. In the case of the *trxB gor* strain, the oxidized thioredoxins can catalyze the formation of disulfide bonds, even when there is sufficient reducing power within the cytoplasm to reduce other essential proteins. In the case of Erv1p, the simple cycling of reduced Erv1p by molecular oxygen is sufficient to catalyze the oxidation of both PhoA and AppA, while both the thioredoxin and glutaredoxin pathways are active. Further improvements to the yields were achieved by pre-expressing Erv1p, prior to the expression of the substrate proteins [151]. The utility of this system was recently demonstrated in the production of camel antibodies [152]. Co-expression of Erv1p along with DsbC or PDI resulted in 10-fold enhancement of yield, reaching yields of tens of milligrams.

Conclusions

Much progress has been achieved since the days of Anfinsen. Today we have a much more in-depth understanding of the processes that govern protein folding. *E. coli* remains a useful model

organism for the study of disulfide bond formation, both in the periplasm and the cytoplasm. Combinations of genetic engineering and fortuitous discoveries have led to the discovery of novel mechanisms of disulfide bond formation. These, in turn, have allowed scientists to engineer new strains and develop novel systems for producing disulfide-bonded proteins. The most recent findings of forming disulfide-bonded proteins within the reducing cytoplasmic environment of wild type cells have broken our chains to last century's dogmas and opened new horizons of what is possible. Expanding our studies to other organisms will undoubtedly bring forth new insights and mechanisms of disulfide bond formation within living cells.

Acknowledgements

I would like to thank Jon Beckwith, Chris Taron, Melanie Berkmen, Paul Riggs and Iris Walker for the critical reading of the manuscript.

References

- [1] E. Haber, C.B. Anfinsen, Regeneration of enzyme activity by air oxidation of reduced subtilisin-modified ribonuclease, *J. Biol. Chem.* 236 (1961) 422–424.
- [2] C.B. Anfinsen, Principles that govern the folding of protein chains, *Science* 181 (1973) 223–230.
- [3] J.C. Bardwell, K. McGovern, J. Beckwith, Identification of a protein required for disulfide bond formation *in vivo*, *Cell* 67 (1991) 581–589.
- [4] B. Heras, M. Kurz, S.R. Shouldice, J.L. Martin, The name's bond: disulfide bond, *Curr. Opin. Struct. Biol.* 17 (2007) 691–698.
- [5] H. Kadokura, F. Katzen, J. Beckwith, Protein disulfide bond formation in prokaryotes, *Annu. Rev. Biochem.* 72 (2003) 111–135.
- [6] H. Kadokura, J. Beckwith, Mechanisms of oxidative protein folding in the bacterial cell envelope, *Antioxid. Redox Signal.* (2010).
- [7] J. Riemer, N. Bulleid, J.M. Herrmann, Disulfide formation in the ER and mitochondria: two solutions to a common process, *Science* 324 (2009) 1284–1287.
- [8] C.S. Sevier, C.A. Kaiser, Formation and transfer of disulphide bonds in living cells, *Nat. Rev. Mol. Cell. Biol.* 3 (2002) 836–847.
- [9] M.J. Feige, L.M. Hendershot, Disulfide bonds in ER protein folding and homeostasis, *Curr. Opin. Cell. Biol.* 23 (2011) 167–175.
- [10] K. Inaba, Structural basis of protein disulfide bond generation in the cell, *Genes Cells* 15 (2010) 935–943.
- [11] G. Walsh, Biopharmaceutical benchmarks 2010, *Nat. Biotechnol.* 28 (2010) 917–924.
- [12] A.G. Khoury, C.R. Baliban, A.C. Floudas, Proteome-wide post-translational modification statistics: frequency analysis and curation of the swiss-prot database, *Scientific Reports* 1 (2011) 1–5.
- [13] J.W. Wong, S.Y. Ho, P.J. Hogg, Disulfide bond acquisition through eukaryotic protein evolution, *Mol. Biol. Evol.* (2010).
- [14] A. Holmgren, Tryptophan fluorescence study of conformational transitions of the oxidized and reduced form of thioredoxin, *J. Biol. Chem.* 247 (1972) 1992–1998.
- [15] M. Wunderlich, R. Jaenicke, R. Glockshuber, The redox properties of protein disulfide isomerase (DsbA) of *Escherichia coli* result from a tense conformation of its oxidized form, *J. Mol. Biol.* 233 (1993) 559–566.
- [16] L. Debarbieux, J. Beckwith, The reductive enzyme thioredoxin 1 acts as an oxidant when it is exported to the *Escherichia coli* periplasm, *Proc. Natl. Acad. Sci. USA* 95 (1998) 10751–10756.
- [17] H. Kadokura, H. Tian, T. Zander, J.C. Bardwell, J. Beckwith, Snapshots of DsbA in action: detection of proteins in the process of oxidative folding, *Science* 303 (2004) 534–537.
- [18] D.E. Fomenko, V.N. Gladyshev, Identity and functions of CxxC-derived motifs, *Biochemistry* 42 (2003) 11214–11225.
- [19] S. Quan, I. Schneider, J. Pan, A. Von Hacht, J.C. Bardwell, The CXXC motif is more than a redox rheostat, *J. Biol. Chem.* 282 (2007) 28823–28833.
- [20] T. Zhang, E. Bertelsen, T. Alber, Entropic effects of disulphide bonds on protein stability, *Nat. Struct. Biol.* 1 (1994) 434–438.
- [21] T.E. Creighton, Disulfide bonds as probes of protein folding pathways, *Methods Enzymol.* 131 (1986) 83–106.
- [22] L.E. Elksne, B.A. Rasmussen, Dsb-insensitive expression of CcrA, a metallo-beta-lactamase from *Bacteroides fragilis*, in *Escherichia coli* after amino acid substitution at two cysteine residues within CcrA, *J. Bacteriol.* 178 (1996) 4306–4309.
- [23] A.A. Laminet, A. Pluckthun, The precursor of beta-lactamase: purification, properties and folding kinetics, *EMBO J.* 8 (1989) 1469–1477.
- [24] L. Zhang, M. Moo-Young, C.P. Chou, Molecular manipulation associated with disulfide bond formation to enhance the stability of recombinant therapeutic protein, *Protein Express. Purif.* 75 (2011) 28–39.

- [25] Reuters, The therapeutic proteins outlook to 2007: An analysis of leading products and late-stage pipeline developments. Reuters Business Insight. (2003).
- [26] F. van den Akker, I.K. Feil, C. Roach, A.A. Platas, E.A. Merritt, W.G. Hol, Crystal structure of heat-labile enterotoxin from *Escherichia coli* with increased thermostability introduced by an engineered disulfide bond in the A subunit, *Protein Sci.* 6 (1997) 2644–2649.
- [27] M. Zavodszky, C.W. Chen, J.K. Huang, M. Zolkiewski, L. Wen, R. Krishnamoorthi, Disulfide bond effects on protein stability: designed variants of *Cucurbita maxima* trypsin inhibitor-V, *Protein Sci.* 10 (2001) 149–160.
- [28] M. Beeby, B.D. O'Connor, C. Ryttersgaard, D.R. Boutz, L.J. Perry, T.O. Yeates, The genomics of disulfide bonding and protein stabilization in thermophiles, *PLoS Biol.* 3 (2005) e309.
- [29] E.A. Toth, C. Worby, J.E. Dixon, E.R. Goedken, S. Marqusee, T.O. Yeates, The crystal structure of adenylosuccinate lyase from *Pyrobaculum aerophilum* reveals an intracellular protein with three disulfide bonds, *J. Mol. Biol.* 301 (2000) 433–450.
- [30] Y. Jiang, S. Nock, M. Nesper, M. Sprinzl, P.B. Sigler, Structure and importance of the dimerization domain in elongation factor Ts from *Thermus thermophilus*, *Biochemistry* 35 (1996) 10269–10278.
- [31] D. Maes, J.P. Zeelen, N. Thanki, N. Beaucamp, M. Alvarez, M.H. Thi, J. Backmann, J.A. Martial, L. Wyns, R. Jaenicke, R.K. Wierenga, The crystal structure of triosephosphate isomerase (TIM) from *Thermotoga maritima*: a comparative thermostability structural analysis of ten different TIM structures, *Proteins* 37 (1999) 441–453.
- [32] B.S. DeDecker, R. O'Brien, P.J. Fleming, J.H. Geiger, S.P. Jackson, P.B. Sigler, The crystal structure of a hyperthermophilic archaeal TATA-box binding protein, *J. Mol. Biol.* 264 (1996) 1072–1084.
- [33] K.P. Hopfner, A. Eichinger, R.A. Engh, F. Laue, W. Ankenbauer, R. Huber, B. Angerer, Crystal structure of a thermostable type B DNA polymerase from *Thermococcus gorgonarius*, *Proc. Natl. Acad. Sci. USA* 96 (1999) 3600–3605.
- [34] E.M. Shepard, E.S. Boyd, J.B. Broderick, J.W. Peters, Biosynthesis of complex iron-sulfur enzymes, *Curr. Opin. Chem. Biol.* 15 (2011) 319–327.
- [35] J.L. Hobman, J. Wilkie, N.L. Brown, A design for life: prokaryotic metal-binding MerR family regulators, *Biometals* 18 (2005) 429–436.
- [36] A. Klug, The discovery of zinc fingers and their applications in gene regulation and genome manipulation, *Annu. Rev. Biochem.* 79 (2010) 213–231.
- [37] R.A. Fabianek, H. Hennecke, L. Thony-Meyer, Periplasmic protein thiol:disulfide oxidoreductases of *Escherichia coli*, *FEMS Microbiol. Rev.* 24 (2000) 303–316.
- [38] F.E. Pai, Variations on a theme: the family of FAD-dependent NAD(P)H-(disulphide)-oxidoreductases, *Curr. Opin. Struct. Biol.* 1 (1991) 796–803.
- [39] C. Lee, S.M. Lee, P. Mukhopadhyay, S.J. Kim, S.C. Lee, W.S. Ahn, M.H. Yu, G. Storz, S.E. Ryu, Redox regulation of OxyR requires specific disulfide bond formation involving a rapid kinetic reaction path, *Nat. Struct. Mol. Biol.* 11 (2004) 1179–1185.
- [40] F.A. Alvarez, D. Georgellis, *In vitro* and *in vivo* analysis of the ArcB/A redox signaling pathway, *Methods Enzymol.* 471 (2010) 205–226.
- [41] J.G. Kang, M.S. Paget, Y.J. Seok, M.Y. Hahn, J.B. Bae, J.S. Hahn, C. Kleanthous, M.J. Buttner, J.H. Roe, RsrA, an anti-sigma factor regulated by redox change, *EMBO J.* 18 (1999) 4292–4298.
- [42] G. Jander, N.L. Martin, J. Beckwith, Two cysteines in each periplasmic domain of the membrane protein DsbB are required for its function in protein disulfide bond formation, *EMBO J.* 13 (1994) 5121–5127.
- [43] A. Holmgren, Thioredoxin and glutaredoxin systems, *J. Biol. Chem.* 264 (1989) 13963–13966.
- [44] D.P. Sideris, K. Tokatlidis, Oxidative protein folding in the mitochondrial intermembrane space, *Antioxid. Redox Signal.* 13 (2010) 1189–1204.
- [45] J.M. Herrmann, R. Kohl, Catch me if you can! Oxidative protein trapping in the intermembrane space of mitochondria, *J. Cell Biol.* 176 (2007) 559–563.
- [46] W.K. Feng, L. Wang, Y. Lu, X.Y. Wang, A protein oxidase catalyzing disulfide bond formation is localized to the chloroplast thylakoids, *FEBS J.* (2011).
- [47] L. Debarbieux, J. Beckwith, On the functional interchangeability, oxidant versus reductant, of members of the thioredoxin superfamily, *J. Bacteriol.* 182 (2000) 723–727.
- [48] U. Grauschopf, J.R. Winther, P. Korber, T. Zander, P. Dallinger, J.C. Bardwell, Why is DsbA such an oxidizing disulfide catalyst?, *Cell* 83 (1995) 947–955.
- [49] S.R. Shouldice, S.H. Cho, D. Boyd, B. Heras, M. Eser, J. Beckwith, P. Riggs, J.L. Martin, M. Berkmen, *In vivo* oxidative protein folding can be facilitated by oxidation-reduction cycling, *Mol. Microbiol.* 75 (2010) 13–28.
- [50] L. Masip, D. Klein-Marcuschamer, S. Quan, J.C. Bardwell, G. Georgiou, Laboratory evolution of *Escherichia coli* thioredoxin for enhanced catalysis of protein oxidation in the periplasm reveals a phylogenetically conserved substrate specificity determinant, *J. Biol. Chem.* 283 (2008) 840–848.
- [51] F. Ferre, P. Clote, DiANNA: a web server for disulfide connectivity prediction, *Nucleic Acids Res.* 33 (2005) W230–W232.
- [52] H.H. Lin, L.Y. Tseng, DBCP: a web server for disulfide bonding connectivity pattern prediction without the prior knowledge of the bonding state of cysteines, *Nucleic Acids Res.* 38 (2010) W503–W507.
- [53] D.E. Fomenko, S.M. Marino, V.N. Gladyshev, Functional diversity of cysteine residues in proteins and unique features of catalytic redox-active cysteines in thiol oxidoreductases, *Mol. Cells* 26 (2008) 228–235.
- [54] R. Singh, A review of algorithmic techniques for disulfide-bond determination, *Brief Funct. Genomic. Proteomic.* 7 (2008) 157–172.
- [55] M.H. Mucchielli-Giorgi, S. Hazout, P. Tuffery, Predicting the disulfide bonding state of cysteines using protein descriptors, *Proteins* 46 (2002) 243–249.
- [56] M.R. Pollock, M.H. Richmond, Low cyst(e)ine content of bacterial extracellular proteins: its possible physiological significance, *Nature* 194 (1962) 446–449.
- [57] R.C. Fahey, J.S. Hunt, G.C. Windham, On the cysteine and cystine content of proteins. Differences between intracellular and extracellular proteins, *J. Mol. Evol.* 10 (1977) 155–160.
- [58] D.J. Brooks, J.R. Fresco, Increased frequency of cysteine, tyrosine, and phenylalanine residues since the last universal ancestor, *Mol. Cell Proteomics* 1 (2002) 125–131.
- [59] Y. Nakamura, T. Gojbori, T. Ikemura, Codon usage tabulated from international DNA sequence databases: status for the year 2000, *Nucleic Acids Res.* 28 (2000) 292.
- [60] P. Mallick, D.R. Boutz, D. Eisenberg, T.O. Yeates, Genomic evidence that the intracellular proteins of archaeal microbes contain disulfide bonds, *Proc. Natl. Acad. Sci. USA* 99 (2002) 9679–9684.
- [61] R.J. Dutton, D. Boyd, M. Berkmen, J. Beckwith, Bacterial species exhibit diversity in their mechanisms and capacity for protein disulfide bond formation, *Proc. Natl. Acad. Sci. USA* 105 (2008) 11933–11938.
- [62] O. Emanuelsson, S. Brunak, G. Von Heijne, H. Nielsen, Locating proteins in the cell using TargetP, SignalP and related tools, *Nat. Protoc.* 2 (2007) 953–971.
- [63] L. Kall, A. Krogh, E.L. Sonnhammer, Advantages of combined transmembrane topology and signal peptide prediction—the Phobius web server, *Nucleic Acids Res.* 35 (2007) W429–W432.
- [64] M.A. Reott, A.C. Parker, E.R. Rocha, C.J. Smith, Thioredoxins in redox maintenance and survival during oxidative stress of *Bacteroides fragilis*, *J. Bacteriol.* 191 (2009) 3384–3391.
- [65] M. Berkmen, D. Boyd, J. Beckwith, Disulfide bond formation in the periplasm, in: M. Ehrmann (Ed.) *The Periplasm*, ASM Press, Washington, D.C., 2006, pp. 122–140.
- [66] F. Hatahet, L.W. Ruddock, Protein disulfide isomerase: a critical evaluation of its function in disulfide bond formation, *Antioxid. Redox Signal.* 11 (2009) 2807–2850.
- [67] M. Dupuydt, J. Messens, J.F. Collet, How proteins form disulfide bonds, *Antioxid. Redox Signal.* 15 (2011) 49–66.
- [68] J.L. Pan, J.C. Bardwell, The origami of thioredoxin-like folds, *Protein Sci.* 15 (2006) 2217–2227.
- [69] M. Huber-Wunderlich, R. Glockshuber, A single dipeptide sequence modulates the redox properties of a whole enzyme family, *Fold. Des.* 3 (1998) 161–171.
- [70] M. Bader, W. Muse, D.P. Ballou, C. Gassner, J.C. Bardwell, Oxidative protein folding is driven by the electron transport system, *Cell* 98 (1999) 217–227.
- [71] L.E. Alksns, D. Keeney, B.A. Rasmussen, A mutation in either *dsbA* or *dsbB*, a gene encoding a component of a periplasmic disulfide bond-catalyzing system, is required for high-level expression of the *Bacteroides fragilis* metallo-beta-lactamase, CcrA, in *Escherichia coli*, *J. Bacteriol.* 177 (1995) 462–464.
- [72] V.E. Shevchik, G. Condemine, J. Robert-Baudouy, Characterization of DsbC, A periplasmic protein of *Erwinia chrysanthemi* and *Escherichia coli* with disulfide isomerase activity, *EMBO J.* 13 (1994) 2007–2012.
- [73] D. Missiakas, C. Georgopoulos, S. Raina, The *Escherichia coli dsbC* (*xprA*) gene encodes a periplasmic protein involved in disulfide bond formation, *EMBO J.* 13 (1994) 2013–2020.
- [74] A.A. McCarthy, P.W. Haebel, A. Torronen, V. Rybin, E.N. Baker, P. Metcalf, Crystal structure of the protein disulfide bond isomerase, DsbC, from *Escherichia coli*, *Nat. Struct. Biol.* 7 (2000) 196–199.
- [75] X. Liu, C.C. Wang, Disulfide-dependent folding and export of *Escherichia coli* DsbC, *J. Biol. Chem.* 276 (2001) 1146–1151.
- [76] A. Rietsch, P. Bessette, G. Georgiou, J. Beckwith, Reduction of the periplasmic disulfide bond isomerase, DsbC, occurs by passage of electrons from cytoplasmic thioredoxin, *J. Bacteriol.* 179 (1997) 6602–6608.
- [77] E.J. Stewart, F. Katzen, J. Beckwith, Six conserved cysteines of the membrane protein DsbD are required for the transfer of electrons from the cytoplasm to the periplasm of *Escherichia coli*, *EMBO J.* 18 (1999) 5963–5971.
- [78] M. Berkmen, D. Boyd, J. Beckwith, The nonconsecutive disulfide bond of *Escherichia coli* phytase (AppA) renders it dependent on the protein-disulfide isomerase, DsbC, *J. Biol. Chem.* 280 (2005) 11387–11394.
- [79] V.S. Devi, P.R. Mittl, Monitoring the disulfide bond formation of a cysteine-rich repeat protein from *Helicobacter pylori* in the periplasm of *Escherichia coli*, *Curr. Microbiol.* 62 (2011) 903–907.
- [80] J.C. Joly, J.R. Swartz, *In vitro* and *in vivo* redox states of the *Escherichia coli* periplasmic oxidoreductases DsbA and DsbC, *Biochemistry* 36 (1997) 10067–10072.
- [81] J.C. Joly, W.S. Leung, J.R. Swartz, Overexpression of *Escherichia coli* oxidoreductases increases recombinant insulin-like growth factor-I accumulation, *Proc. Natl. Acad. Sci. USA* 95 (1998) 2773–2777.
- [82] J. Qiu, J.R. Swartz, G. Georgiou, Expression of active human tissue-type plasminogen activator in *Escherichia coli*, *Appl. Environ. Microbiol.* 64 (1998) 4891–4896.
- [83] Z. Zhang, Z.H. Li, F. Wang, M. Fang, C.C. Yin, Z.Y. Zhou, Q. Lin, H.L. Huang, Overexpression of DsbC and DsbG markedly improves soluble and functional expression of single-chain Fv antibodies in *Escherichia coli*, *Protein Expres. Purif.* 26 (2002) 218–228.
- [84] K. Maskos, M. Huber-Wunderlich, R. Glockshuber, DsbA and DsbC-catalyzed oxidative folding of proteins with complex disulfide bridge patterns *in vitro* and *in vivo*, *J. Mol. Biol.* 325 (2003) 495–513.

- [85] Y. Kurokawa, H. Yanagi, T. Yura, Overexpression of protein disulfide isomerase DsbC stabilizes multiple-disulfide-bonded recombinant protein produced and transported to the periplasm in *Escherichia coli*, *Appl. Environ. Microbiol.* 66 (2000) 3960–3965.
- [86] Y. Kurokawa, H. Yanagi, T. Yura, Overproduction of bacterial protein disulfide isomerase (DsbC) and its modulator (DsbD) markedly enhances periplasmic production of human nerve growth factor in *Escherichia coli*, *J. Biol. Chem.* 276 (2001) 14393–14399.
- [87] L. Ferbitz, T. Maier, H. Patzelt, B. Bukau, E. Deuerling, N. Ban, Trigger factor in complex with the ribosome forms a molecular cradle for nascent proteins, *Nature* 431 (2004) 590–596.
- [88] J. Chen, J.L. Song, S. Zhang, Y. Wang, D.F. Cui, C.C. Wang, Chaperone activity of DsbC, *J. Biol. Chem.* 274 (1999) 19601–19605.
- [89] K. Tsumoto, M. Umetsu, H. Yamada, T. Ito, S. Misawa, I. Kumagai, Immobilized oxidoreductase as an additive for refolding inclusion bodies: application to antibody fragments, *Protein Eng.* 16 (2003) 535–541.
- [90] X.X. Sun, C.C. Wang, The N-terminal sequence (residues 1–65) is essential for dimerization, Activities, and peptide binding of *Escherichia coli* DsbC, *J. Biol. Chem.* 275 (2000) 22743–22749.
- [91] G. Richarme, T.D. Caldas, Chaperone properties of the bacterial periplasmic substrate-binding proteins, *J. Biol. Chem.* 272 (1997) 15607–15612.
- [92] F. Schlunzen, D.N. Wilson, P. Tian, J.M. Harms, S.J. McInnes, H.A. Hansen, R. Albrecht, J. Buerger, S.M. Wilbanks, P. Fucini, The binding mode of the trigger factor on the ribosome: implications for protein folding and SRP interaction, *Structure* 13 (2005) 1685–1694.
- [93] A. Zapun, D. Missiakas, S. Raina, T.E. Creighton, Structural and functional characterization of DsbC, a protein involved in disulfide bond formation in *Escherichia coli*, *Biochemistry* 34 (1995) 5075–5089.
- [94] Z. Zhao, Y. Peng, S.F. Hao, Z.H. Zeng, C.C. Wang, Dimerization by domain hybridization bestows chaperone and isomerase activities, *J. Biol. Chem.* 278 (2003) 43292–43298.
- [95] G. Ren, J.C. Bardwell, Engineered pathways for correct disulfide bond oxidation, *Antioxid. Redox Signal.* 14 (2011) 2399–2412.
- [96] X. Zhan, J. Gao, C. Jain, M.J. Cieslewicz, J.R. Swartz, G. Georgiou, Genetic analysis of disulfide isomerization in *Escherichia coli*: expression of DsbC is modulated by RNase E-dependent mRNA processing, *J. Bacteriol.* 186 (2004) 654–660.
- [97] B. Heras, M.A. Edeling, H.J. Schirra, S. Raina, J.L. Martin, Crystal structures of the DsbG disulfide isomerase reveal an unstable disulfide, *Proc. Natl. Acad. Sci. USA* 101 (2004) 8876–8881.
- [98] C.L. Andersen, A. Matthey-Dupraz, D. Missiakas, S. Raina, A new *Escherichia coli* gene, DsbG, encodes a periplasmic protein involved in disulphide bond formation, required for recycling DsbA/DsbB and DsbC redox proteins, *Mol. Microbiol.* 26 (1997) 121–132.
- [99] F. Shao, M.W. Bader, U. Jakob, J.C. Bardwell, DsbG, a protein disulfide isomerase with chaperone activity, *J. Biol. Chem.* 275 (2000) 13349–13352.
- [100] P.H. Bessette, J.J. Cotto, H.F. Gilbert, G. Georgiou, *In vivo* and *in vitro* function of the *Escherichia coli* periplasmic cysteine oxidoreductase DsbG, *J. Biol. Chem.* 274 (1999) 7784–7792.
- [101] M. Depuydt, S.E. Leonard, D. Vertommen, K. Denoncin, P. Morsomme, K. Wahni, J. Messens, K.S. Carroll, J.F. Collet, A periplasmic reducing system protects single cysteine residues from oxidation, *Science* 326 (2009) 1109–1111.
- [102] A. Hiniker, G. Ren, B. Heras, Y. Zheng, S. Laurinec, R.W. Jobson, J.A. Stuckey, J.L. Martin, J.C. Bardwell, Laboratory evolution of one disulfide isomerase to resemble another, *Proc. Natl. Acad. Sci. USA* 104 (2007) 11670–11675.
- [103] A.R. Frand, J.W. Cuozzo, C.A. Kaiser, Pathways for protein disulphide bond formation, *Trends Cell. Biol.* 10 (2000) 203–210.
- [104] M. Ostermeier, K. De Sutter, G. Georgiou, Eukaryotic protein disulfide isomerase complements *Escherichia coli* dsbA mutants and increases the yield of a heterologous secreted protein with disulfide bonds, *J. Biol. Chem.* 271 (1996) 10616–10622.
- [105] D.P. Humphreys, N. Weir, A. Lawson, A. Mountain, P.A. Lund, Co-expression of human protein disulphide isomerase (PDI) can increase the yield of an antibody Fab' fragment expressed in *Escherichia coli*, *FEBS Lett.* 380 (1996) 194–197.
- [106] D.P. Humphreys, N. Weir, A. Mountain, P.A. Lund, Human protein disulfide isomerase functionally complements a *dsbA* mutation and enhances the yield of pectate lyase C in *Escherichia coli*, *J. Biol. Chem.* 270 (1995) 28210–28215.
- [107] L. Masip, J.L. Pan, S. Haldar, J.E. Penner-Hahn, M.P. DeLisa, G. Georgiou, J.C. Bardwell, J.F. Collet, An engineered pathway for the formation of protein disulfide bonds, *Science* 303 (2004) 1185–1189.
- [108] M. Eser, L. Masip, H. Kadokura, G. Georgiou, J. Beckwith, Disulfide bond formation by exported glutaredoxin indicates glutathione's presence in the *E. Coli* periplasm, *Proc. Natl. Acad. Sci. USA* 106 (2009) 1572–1577.
- [109] M.W. Bader, A. Hiniker, J. Regeimbal, D. Goldstone, P.W. Haebel, J. Riemer, P. Metcalf, J.C. Bardwell, Turning a disulfide isomerase into an oxidase: DsbC mutants that imitate DsbA, *EMBO J.* 20 (2001) 1555–1562.
- [110] L. Segatori, L. Murphy, S. Arredondo, H. Kadokura, H. Gilbert, J. Beckwith, G. Georgiou, Conserved role of the linker alpha-helix of the bacterial disulfide isomerase DsbC in the avoidance of misoxidation by DsbB, *J. Biol. Chem.* 281 (2006) 4911–4919.
- [111] S. Arredondo, L. Segatori, H.F. Gilbert, G. Georgiou, *De novo* design and evolution of artificial disulfide isomerase enzymes analogous to the bacterial DsbC, *J. Biol. Chem.* 283 (2008) 31469–31476.
- [112] T. Kobayashi, K. Ito, Respiratory chain strongly oxidizes the CXXC motif of DsbB in the *Escherichia coli* disulfide bond formation pathway, *EMBO J.* 18 (1999) 1192–1198.
- [113] B. Holst, C. Tachibana, J.R. Winther, Active site mutations in yeast protein disulfide isomerase cause dithiothreitol sensitivity and a reduced rate of protein folding in the endoplasmic reticulum, *J. Cell. Biol.* 138 (1997) 1229–1238.
- [114] P.H. Bessette, J. Qiu, J.C. Bardwell, J.R. Swartz, G. Georgiou, Effect of sequences of the active-site dipeptides of DsbA and DsbC on *in vivo* folding of multidisulfide proteins in *Escherichia coli*, *J. Bacteriol.* 183 (2001) 980–988.
- [115] H.J. Schirra, C. Renner, M. Czisch, M. Huber-Wunderlich, T.A. Holak, R. Glockshuber, Structure of reduced DsbA from *Escherichia coli* in solution, *Biochemistry* 37 (1998) 6263–6276.
- [116] W.D. Zheng, H. Quan, J.L. Song, S.L. Yang, C.C. Wang, Does DsbA have chaperone-like activity?, *Arch. Biochem. Biophys.* 337 (1997) 326–331.
- [117] L.A. Collins-Racie, J.M. McColgan, K.L. Grant, E.A. DiBlasio-Smith, J.M. McCoy, E.R. LaVallie, Production of recombinant bovine enterokinase catalytic subunit in *Escherichia coli* using the novel secretory fusion partner DsbA, *Biotechnology (N.Y.)* 13 (1995) 982–987.
- [118] C.F. Fan, R.H. Zeng, C.Y. Sun, X.G. Mei, Y.F. Wang, Y. Liu, Fusion of DsbA to the N-terminus of CTL chimeric epitope, F/M2:81–95, of respiratory syncytial virus prolongs protein- and virus-specific CTL responses in Balb/c mice, *Vaccine* 23 (2005) 2869–2875.
- [119] Y. Liu, T.J. Zhao, Y.B. Yan, H.M. Zhou, Increase of soluble expression in *Escherichia coli* cytoplasm by a protein disulfide isomerase gene fusion system, *Protein Express. Purif.* 44 (2005) 155–161.
- [120] H. Chun, K. Joo, J. Lee, H.C. Shin, Design and efficient production of bovine enterokinase light chain with higher specificity in *E.coli*, *Biotechnol. Lett.* 33 (2011) 1227–1232.
- [121] T. Kajino, C. Ohto, M. Muramatsu, S. Obata, S. Udaka, Y. Yamada, H. Takahashi, A protein disulfide isomerase gene fusion expression system that increases the extracellular productivity of *Bacillus brevis*, *Appl. Environ. Microbiol.* 66 (2000) 638–642.
- [122] T. Yasukawa, C. Kanei-Ishii, T. Maekawa, J. Fujimoto, T. Yamamoto, S. Ishii, Increase of solubility of foreign proteins in *Escherichia coli* by coproduction of the bacterial thioredoxin, *J. Biol. Chem.* 270 (1995) 25328–25331.
- [123] E.J. Stewart, F. Aslund, J. Beckwith, Disulfide bond formation in the *Escherichia coli* cytoplasm: an *in vivo* role reversal for the thioredoxins, *EMBO J.* 17 (1998) 5543–5550.
- [124] A.I. Derman, J. Beckwith, *Escherichia coli* alkaline phosphatase fails to acquire disulfide bonds when retained in the cytoplasm, *J. Bacteriol.* 173 (1991) 7719–7722.
- [125] W.A. Prinz, F. Aslund, A. Holmgren, J. Beckwith, The role of the thioredoxin and glutaredoxin pathways in reducing protein disulfide bonds in the *Escherichia coli* cytoplasm, *J. Biol. Chem.* 272 (1997) 15661–15667.
- [126] C.H. Williams, Jr., Mechanism and structure of thioredoxin reductase from *Escherichia coli*, *FASEB J.* 9 (1995) 1267–1276.
- [127] F. Aslund, M. Zheng, J. Beckwith, G. Storz, Regulation of the OxyR transcription factor by hydrogen peroxide and the cellular thiol-disulfide status, *Proc. Natl. Acad. Sci. USA* 96 (1999) 6161–6165.
- [128] L. Masip, K. Veeravalli, G. Georgiou, The many faces of glutathione in bacteria, *Antioxid. Redox Signal.* 8 (2006) 753–762.
- [129] S. Gon, M.J. Faulkner, J. Beckwith, *In vivo* requirement for glutaredoxins and thioredoxins in the reduction of the ribonucleotide reductases of *Escherichia coli*, *Antioxid. Redox Signal.* 8 (2006) 735–742.
- [130] R. Ortenberg, S. Gon, A. Porat, J. Beckwith, Interactions of glutaredoxins, ribonucleotide reductase, and components of the DNA replication system of *Escherichia coli*, *Proc. Natl. Acad. Sci. USA* 101 (2004) 7439–7444.
- [131] D. Ritz, J. Lim, C.M. Reynolds, L.B. Poole, J. Beckwith, Conversion of a peroxidoreduxin into a disulfide reductase by a triplet repeat expansion, *Science* 294 (2001) 158–160.
- [132] Y. Yamamoto, D. Ritz, A.G. Planson, T.J. Jonsson, M.J. Faulkner, D. Boyd, J. Beckwith, L.B. Poole, Mutant AhpC peroxidoreduxins suppress thiol-disulfide redox deficiencies and acquire deglutathionylating activity, *Mol. Cell* 29 (2008) 36–45.
- [133] P.H. Bessette, F. Aslund, J. Beckwith, G. Georgiou, Efficient folding of proteins with multiple disulfide bonds in the *Escherichia coli* cytoplasm, *Proc. Natl. Acad. Sci. USA* 96 (1999) 13703–13708.
- [134] M. Kumano-Kuramochi, Q. Xie, Y. Sakakibara, S. Niimi, K. Sekizawa, S. Komba, S. Machida, Expression and characterization of recombinant C-terminal biotinylated extracellular domain of human receptor for advanced glycation end products (hsRAGE) in *Escherichia coli*, *J. Biochem.* 143 (2008) 229–236.
- [135] C. Drees, C.A. Sturmer, H.M. Moller, G. Fritz, Expression and purification of neurolin immunoglobulin domain 2 from *Carrassius auratus* (goldfish) in *Escherichia coli*, *Protein Express. Purif.* 59 (2008) 47–54.
- [136] Y. Xu, D. Lewis, C.P. Chou, Effect of folding factors in rescuing unstable heterologous lipase B to enhance its overexpression in the periplasm of *Escherichia coli*, *Appl. Microbiol. Biotechnol.* 79 (2008) 1035–1044.
- [137] M.W. Larsen, U.T. Bornscheuer, K. Hult, Expression of *Candida antarctica* lipase B in *Pichia pastoris* and various *Escherichia coli* systems, *Protein Express. Purif.* 62 (2008) 90–97.
- [138] M. Kaomek, K. Mizuno, T. Fujimura, P. Sriyotha, J.R. Cairns, Cloning, expression, and characterization of an antifungal chitinase from *Leucaena leucocephala de Wit*, *Biosci. Biotechnol. Biochem.* 67 (2003) 667–676.

- [139] M. Bar, R. Bar-Ziv, T. Scherf, D. Fass, Efficient production of a folded and functional, highly disulfide-bonded beta-helix antifreeze protein in bacteria, *Protein Expres. Purif.* 48 (2006) 243–252.
- [140] P. Jurado, D. Ritz, J. Beckwith, V. De Lorenzo, L.A. Fernandez, Production of functional single-chain Fv antibodies in the cytoplasm of *Escherichia coli*, *J. Mol. Biol.* 320 (2002) 1–10.
- [141] N.J. Darby, S. Raina, T.E. Creighton, Contributions of substrate binding to the catalytic activity of DsbC, *Biochemistry* 37 (1998) 783–791.
- [142] A.R. Tait, S.K. Straus, Overexpression and purification of U24 from human herpesvirus type-6 in *E. coli*: unconventional use of oxidizing environments with a maltose binding protein-hexahistidine dual tag to enhance membrane protein yield, *Microb. Cell Fact.* 10 (2011) 51.
- [143] G. Kramer, D. Boehringer, N. Ban, B. Bukau, The ribosome as a platform for co-translational processing, folding and targeting of newly synthesized proteins, *Nat. Struct. Mol. Biol.* 16 (2009) 589–597.
- [144] H. Ostergaard, C. Tachibana, J.R. Winther, Monitoring disulfide bond formation in the eukaryotic cytosol, *J. Cell Biol.* 166 (2004) 337–345.
- [145] J. Messens, J.F. Collet, K. Van Belle, E. Brosens, R. Loris, L. Wyns, The oxidase DsbA folds a protein with a nonconsecutive disulfide, *J. Biol. Chem.* 282 (2007) 31302–31307.
- [146] A. Neubauer, P. Neubauer, J. Myllyharju, High-level production of human collagen prolyl 4-hydroxylase in *Escherichia coli*, *Matrix Biol.* 24 (2005) 59–68.
- [147] D. Ritz, H. Patel, B. Doan, M. Zheng, F. Aslund, G. Storz, J. Beckwith, Thioredoxin 2 is involved in the oxidative stress response in *Escherichia coli*, *J. Biol. Chem.* 275 (2000) 2505–2512.
- [148] A. Miranda-Vizuete, A.E. Damdimopoulos, J. Gustafsson, G. Spyrou, Cloning, expression, and characterization of a novel *Escherichia coli* thioredoxin, *J. Biol. Chem.* 272 (1997) 30841–30847.
- [149] N. Kovalskaya, R.W. Hammond, Expression and functional characterization of the plant antimicrobial snakin-1 and defensin recombinant proteins, *Protein Expres. Purif.* 63 (2009) 12–17.
- [150] F. Hatahet, V.D. Nguyen, K.E. Salo, L.W. Ruddock, Disruption of reducing pathways is not essential for efficient disulfide bond formation in the cytoplasm of *E. coli*, *Microb. Cell Fact.* 9 (2010) 67.
- [151] V.D. Nguyen, F. Hatahet, K.E. Salo, E. Enlund, C. Zhang, L.W. Ruddock, Pre-expression of a sulfhydryl oxidase significantly increases the yields of eukaryotic disulfide bond containing proteins expressed in the cytoplasm of *E. coli*, *Microb. Cell. Fact.* 10 (2011) 1.
- [152] G. Veggiani, A. de Marco, Improved quantitative and qualitative production of single-domain intrabodies mediated by the co-expression of Erv1p sulfhydryl oxidase, *Protein Expres. Purif.* 79 (2011) 111–114.
- [153] M. Sone, Y. Akiyama, K. Ito, Differential in vivo roles played by DsbA and DsbC in the formation of protein disulfide bonds, *J. Biol. Chem.* 272 (1997) 10349–10352.
- [154] A. Hiniker, J.C. Bardwell, *In vivo* substrate specificity of periplasmic disulfide oxidoreductases, *J. Biol. Chem.* 279 (2004) 12967–12973.